



SimpleLine II
Product/Manual Catalog

Dentium
For Dentists By Dentists

SimpleLine II

A New Choice

For the Customer

PRODUCT CATALOG

Introduction

S.L.A. Surface	04
SimpleLine II Characteristics	06
SimpleLine II Color Coding by Diameter	07
SimpleLine II Fixture	08

Surgical Components

Cover Screw & Healing Abutment	10
--------------------------------	----

Prosthetic Procedure 1

<i>Solid / Dual / SCA Abutment</i>	12
Solid Abutment	13
Dual Abutment	14
Abutment Level Impression Components- Solid / Dual Abutment	15
SCA Abutment	16
Abutment Level Impression Components- SCA Abutment	17
Restorative Kit	18

Prosthetic Procedure 2

<i>Dual / SCA / Dual Milling / Angled / Direct-Casting Abutment / Metal-Casting Abutment</i>	19
Fixture Level Impression Components	20
Dual Milling / Angled / Direct-Casting / Metal-Casting Abutment	21
Temporary Abutment(Ti / Plastic) / Analog	24

Prosthetic Procedure 3

<i>Screw Abutment</i>	26
Screw Abutment	27
Screw Abutment Impression Components	28

Prosthetic Procedure 4

<i>Overdenture Procedure - Positioner / Ball / Magnetic Attachment</i>	32
Positioner	33
Mini Ball Attachment	35
Magnetic Attachment	36

Instruments

SimpleLine II Surgical Kit	37
Drill	38
Instrument	39
Prosthetic Kit	41
Prosthetic and Laboratory Instrument	42

Surgical Manual	44
Prosthetic Manual	49



S.L.A. Surface

S.L.A. (Sandblasting with large grit and acid etching)

- Higher bone-to-implant contact.
- Faster bone formation on the surface.

In vivo test

SimpleLine II Characteristics

Ti-Retaining Screw

- Smaller diameter of abutment screw has reduced a tendency of falling off a resin in the screw hole.
- More stable occlusal scheme

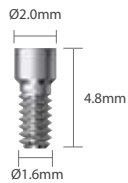

Double-threaded Design

- Sharpened thread design promotes better initial stability in soft bone
- Easy & fast insertion can be done due to double threaded straight body design

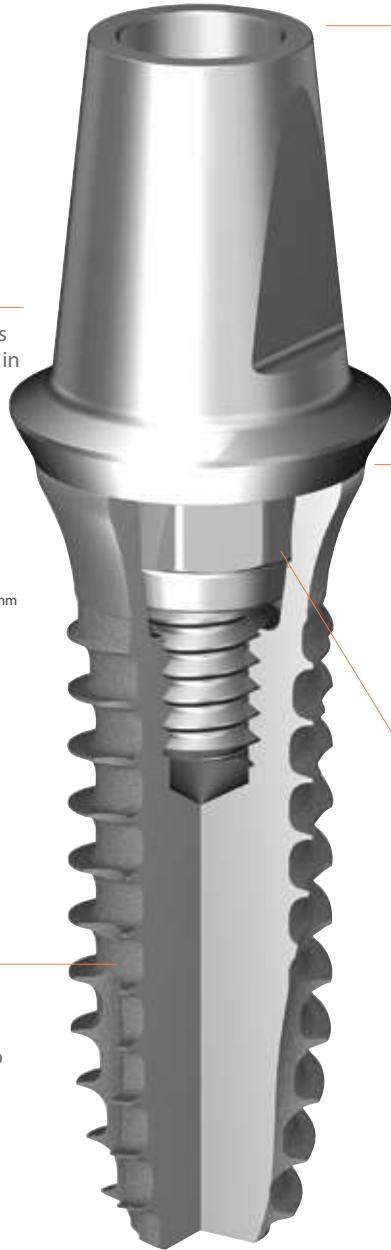
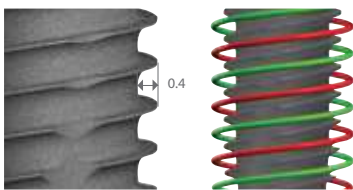

SCA Abutment

- Offers additional gingival height options
- Implantation with the SCA Abutment
- Able to reproduce emergence profile
- Effective soft tissue management

8 degree Morse Taper Octagon Connection

- Screw loosening is well prevented due to the cold welding mechanism for solid abutment application.
- Maximized depth of the octagon design to enable easy adaptation verification for dual abutment application.







SimpleLine II Color Coding by Diameter

Color Coding by Diameter

• Cover screw is not included in the packaging.

(Unit: mm)

Cap Color						
Fixture SimpleLine II (Mount Free)						
	A Platform Diameter	4.8	4.8	4.8	6.5	6.5
	B Body Diameter	3.4	3.8	4.3	4.3	4.8
	C Bevel Height	0.55	0.55	0.55	0.75	0.75
	D Gingival Height	2.0	2.0	2.0	2.0	2.0

SimpleLine II Fixture

Unit: mm, Scale 1 : 1.5 / mm

Platform Ø4.8 | Body Ø3.4

L	Art. No.
08	SOFX 4834 08 R
10	SOFX 4834 10 R
12	SOFX 4834 12 R

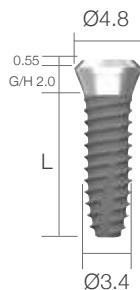

Platform Ø4.8 | Body Ø3.8

L	Art. No.
08	SOFX 4838 08 R
10	SOFX 4838 10 R
12	SOFX 4838 12 R

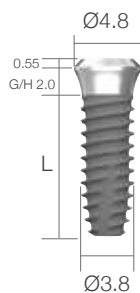

Platform Ø4.8 | Body Ø4.3

L	Art. No.
08	SOFX 4843 08 R
10	SOFX 4843 10 R
12	SOFX 4843 12 R

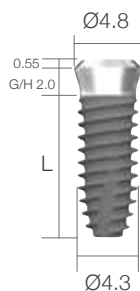

SimpleLine II Fixture

Platform Ø6.5 | Body Ø4.3

L	Art. No.
08	SOFX 6543 08 R
10	SOFX 6543 10 R
12	SOFX 6543 12 R

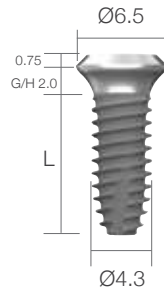

Platform Ø6.5 | Body Ø4.8

L	Art. No.
08	SOFX 6548 08 R
10	SOFX 6548 10 R
12	SOFX 6548 12 R

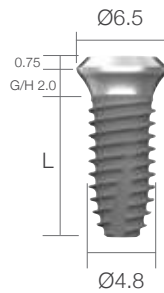

Cover Screw

Unit:mm, Scale 1: 1.5 / mm



SOCS4835 and SOFX483810R

Cover Screw | Single use only

Application	Diameter	Art. No.
Ø4.8	Ø3.5	SOCS 48 35
Ø6.5	Ø4.3	SOCS 65 43



Healing Abutment

Unit:mm, Scale 1: 1.5 / mm



SOHAB4820 and SOFX483810R

Healing Abutment | Single use only

Application	H	Art. No.
Ø4.8	2.0	SOHAB 48 20
	4.0	SOHAB 48 40
Ø6.5	2.0	SOHAB 65 20
	4.0	SOHAB 65 40



Prosthetic Procedure 1

Impression Technique and Restoration Selection

Solid / Dual / SCA Abutment

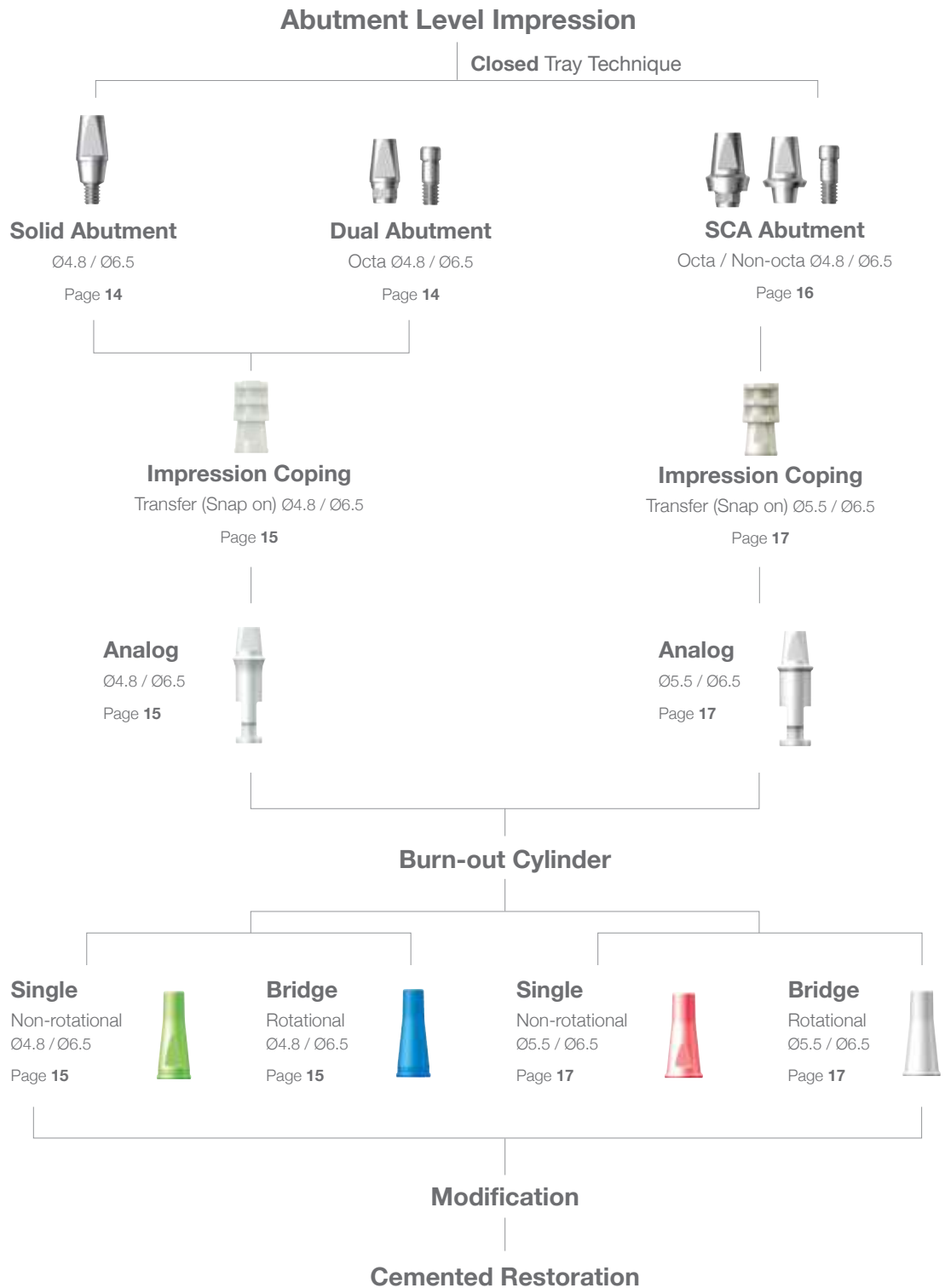

Solid Abutment

Unit:mm, Scale 1: 1.5 / mm



SOSAB4840N and SOFX483810R

Application Ø4.8 | One piece

H	Art. No.
4.0	SOSAB 48 40 N
5.5	SOSAB 48 55 N
7.0	SOSAB 48 70 N

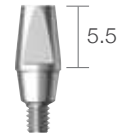

Application Ø6.5 | One piece

H	Art. No.
4.0	SOSAB 65 40 N
5.5	SOSAB 65 55 N
7.0	SOSAB 65 70 N



Dual Abutment

- Abutment screw is included.

Unit:mm, Scale 1: 1.5 / mm



SODAB48550 and SOFX483810R

Application Ø4.8 | Octa

H	Art. No.
4.0	SODAB 48 40 O
5.5	SODAB 48 55 O
7.0	SODAB 48 70 O

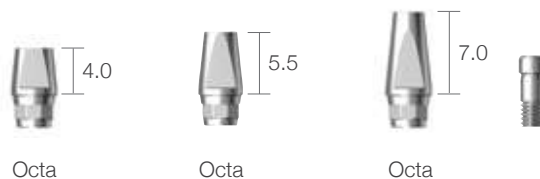

Application Ø6.5 | Octa

H	Art. No.
4.0	SODAB 65 40 O
5.5	SODAB 65 55 O
7.0	SODAB 65 70 O

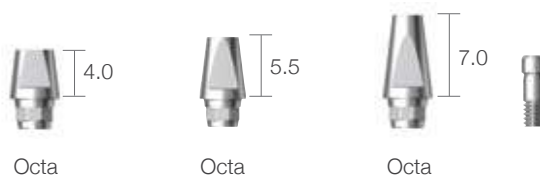

Abutment Screw

Art. No.	SOAAS 20 23
----------	--------------------



Abutment Level Impression Components

Unit:mm, Scale 1: 1.5 / mm

Comfort Cap | Solid / Dual Abutment

Application	H	Art. No.
Ø4.8	6.0	SODCC 48 40
	7.5	SODCC 48 55
	9.0	SODCC 48 70
Ø6.5	6.0	SODCC 65 40
	7.5	SODCC 65 55
	9.0	SODCC 65 70

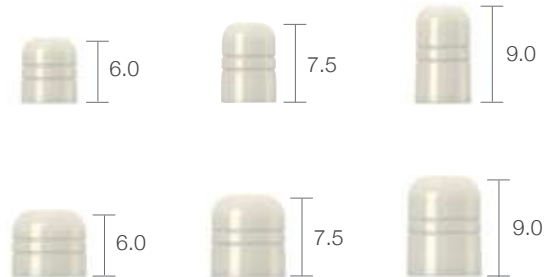

Impression Coping | Solid / Dual Abutment

Application	Diameter	Art. No.
Ø4.8	Ø4.8	SODIC 48
Ø6.5	Ø6.5	SODIC 65



Analog | Solid / Dual Abutment

Application	H	Art. No.
Ø4.8	4.0	SOCAN 48 40 P
	5.5	SOCAN 48 55 P
	7.0	SOCAN 48 70 P
Ø6.5	4.0	SOCAN 65 40 P
	5.5	SOCAN 65 55 P
	7.0	SOCAN 65 70 P

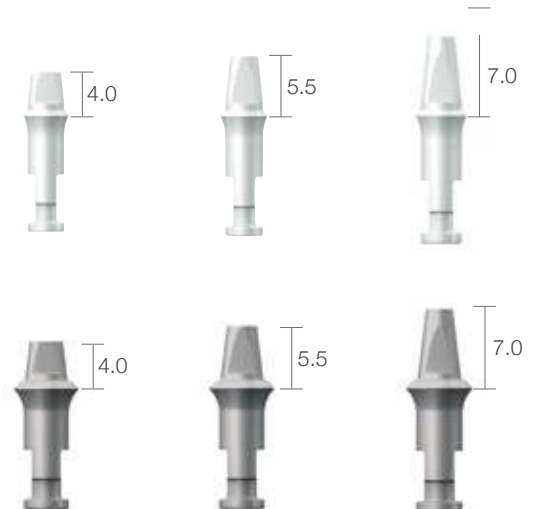

Burn-out Cylinder | Solid / Dual Abutment

Application	Type	Art. No.
Ø4.8	Single	SODBC 48 S
	Bridge	SODBC 48 B
Ø6.5	Single	SODBC 65 S
	Bridge	SODBC 65 B

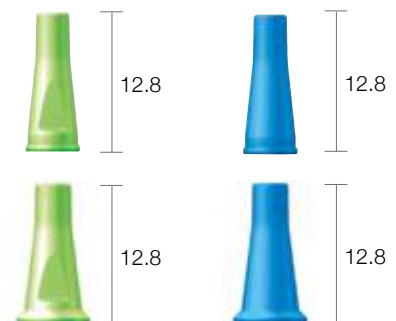

SCA Abutment

- Abutment screw is included.

Unit:mm, Scale 1: 1.5 / mm



SOCAB48080 and SOFX483810R

Application Ø4.8

G/H	Type	Art. No.
0.8	Octa	SOCAB 48 08 O
	Non-octa	SOCAB 48 08 N
1.8	Octa	SOCAB 48 18 O
	Non-octa	SOCAB 48 18 N

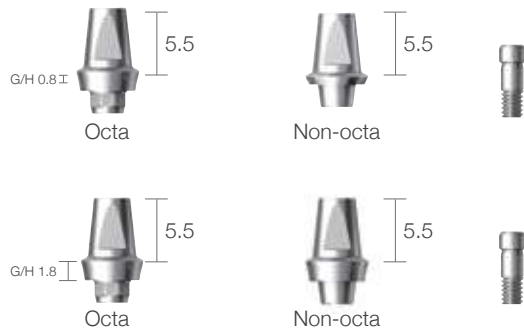

Application Ø6.5

G/H	Type	Art. No.
0.8	Octa	SOCAB 65 08 O
	Non-octa	SOCAB 65 08 N
1.8	Octa	SOCAB 65 18 O
	Non-octa	SOCAB 65 18 N



Abutment Level Impression Components

Unit:mm, Scale 1: 1.5 / mm

Comfort Cap | SCA Abutment

Application	Diameter	Art. No.
Ø4.8	Ø5.5	CCC 55 C
Ø6.5	Ø6.5	CCC 65 C



Impression Coping | SCA Abutment

Application	Diameter	Art. No.
Ø4.8	Ø5.5	CIC 55 L
Ø6.5	Ø6.5	CIC 65 L



Analog | SCA Abutment

Application	Diameter	Art. No.
Ø4.8	Ø5.5	CAN 55 LL
Ø6.5	Ø6.5	CAN 65 LL

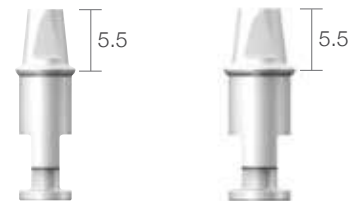

Burn-out Cylinder | SCA Abutment

Application	Type	Art. No.
Ø4.8	Single Bridge	CBC 55 SL
		CBC 55 BL
Ø6.5	Single Bridge	CBC 65 SL
		CBC 65 BL

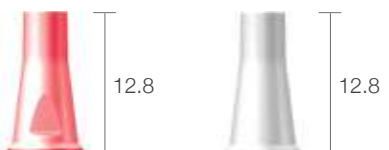
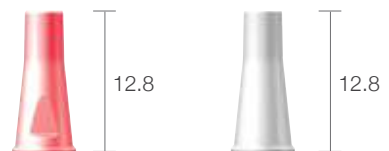

Restorative Kit



Solid & Dual Abutment

Art. No	Lab Components				
	Comfort Cap	Impression Coping	Analog	Burn-out Cylinder	
XSSODAB 48 40	SODCC 48 40	SODIC 48	SOCAN 48 40 P	SODBC 48 S	SODBC 48 B
XSSODAB 48 55	SODCC 48 55		SOCAN 48 55 P		
XSSODAB 48 70	SODCC 48 70		SOCAN 48 70 P		
XSSODAB 65 40	SODCC 65 40	SODIC 65	SOCAN 65 40 P	SODBC 65 S	SODBC 65 B
XSSODAB 65 55	SODCC 65 55		SOCAN 65 55 P		
XSSODAB 65 70	SODCC 65 70		SOCAN 65 70 P		

SCA Abutment

Art. No	Lab Components				
	Comfort Cap	Impression Coping	Analog	Burn-out Cylinder	
XSSOCAB 48 S	CCC 55 CS	CIC 55 L	CAN 55 SL	CBC 55 SL	CBC 55 BL
XSSOCAB 48	CCC 55 C		CAN 55 LL		
XSSOCAB 65 S	CCC 65 CS	CIC 65 L	CAN 65 SL	CBC 65 SL	CBC 65 BL
XSSOCAB 65	CCC 65 C		CAN 65 LL		

Prosthetic Procedure 2

Impression Technique and Restoration Selection

Dual / SCA / Dual Milling / Angled / Direct-Casting / Metal-Casting / Temporary Abutment

Fixture Level Impression

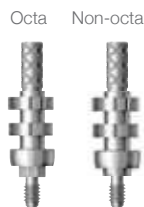

Impression Coping / Pick-up

Open tray technique (Complicated case)
Ø4.8 / Ø6.5

Page 20



Impression Coping / Transfer

Closed tray technique (Simple case)
Ø4.8 / Ø6.5

Page 20



Analog

Ø4.8 / Ø6.5

Page 22



Modification

Cemented Restoration

Modification

Screw-Retained Restoration

Fixture Level Impression Components

Unit:mm, Scale 1: 1.5 / mm

Impression Coping Pick-up

Application	Type	Art. No.
Ø4.8	Octa	SODPU 48 52 O
	Non-Octa	SODPU 48 52 N
Ø6.5	Octa	SODPU 65 68 O
	Non-Octa	SODPU 65 68 N

Ø5.2



Octa

Ø5.2



Non-octa



Ø6.8



Octa

Ø6.8



Non-octa



Impression Coping Transfer

Application	Type	Art. No.
Ø4.8	Octa	SODTF 48 52 O
	Non-Octa	SODTF 48 52 N
Ø6.5	Octa	SODTF 65 68 O
	Non-Octa	SODTF 65 68 N

Ø5.2



Octa

Ø5.2



Non-octa



Ø6.8



Octa

Ø6.8



Non-octa



Impression Coping Screw

Type	Art. No.
Pick-up	SODPS 11
Transfer	SODTS 11



19.5



13.5

Dual Milling Abutment

- Abutment screw is included.

Unit:mm, Scale 1: 1.5 / mm



SOMAB4830OG and SOFX483810R

Application Ø4.8 | Octa

Type	Art. No.
Octa	SOMAB 48 30 OG



Application Ø6.5 | Octa

Type	Art. No.
Octa	SOMAB 65 30 OG
Octa	SOMAB 75 30 OG



Angled Abutment

- Abutment screw is included.

Unit:mm, Scale 1: 1.5 / mm



SOAAB4815O and SOFX483810R

Diameter Ø4.8 | Octa

Angled	Art. No.
15°	SOAAB 48 15 O
25°	SOAAB 48 25 O



Octa



Octa



Diameter Ø6.5 | Octa

Angled	Art. No.
15°	SOAAB 65 15 O
25°	SOAAB 65 25 O



Octa



Octa



Direct Casting Abutment

- Abutment screw is included.

Unit:mm, Scale 1: 1.5 / mm



SOCS4835 and SOFX483810R

Diameter Ø4.8 | Gold

Type	Art. No.
Octa	SORAB 48 52 O
Non-octa	SORAB 48 52 N



Diameter Ø6.5 | Gold

Type	Art. No.
Octa	SORAB 65 68 O
Non-octa	SORAB 65 68 N



Metal-Casting Abutment

- Abutment screw is included.

Unit:mm, Scale 1: 1.5 / mm



SORAB4852CO and SOFX483810R

Diameter Ø4.8 | Co-Cr

Type	Art. No.
Octa	SORAB 48 52 CO
Non-octa	SORAB 48 52 CN

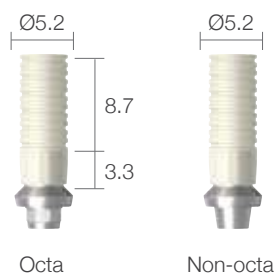

Diameter Ø6.5 | Co-Cr

Type	Art. No.
Octa	SORAB 65 68 CO
Non-octa	SORAB 65 68 CN

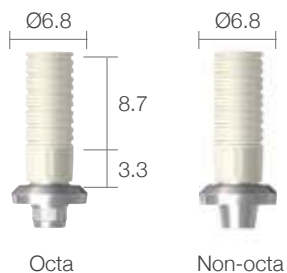

Temporary Abutment

- Abutment screw is included.

Unit:mm, Scale 1: 1.5 / mm



SOTAB4852TOG and SOFX483810R



SOTAB4852PO and SOFX483810R

Temporary Abutment - Ti

Application	Type	Art. No.
Ø4.8	Octa	SOTAB 48 52 TOG
	Non-octa	SOTAB 48 52 TNG
Ø6.5	Octa	SOTAB 65 68 TOG
	Non-octa	SOTAB 65 68 TNG

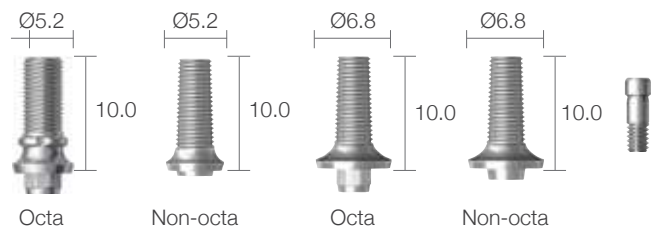

Temporary Abutment - Plastic

Application	Type	Art. No.
Ø4.8	Octa	SOTAB 48 52 PO
	Non-octa	SOTAB 48 52 PN
Ø6.5	Octa	SOTAB 65 68 PO
	Non-octa	SOTAB 65 68 PN

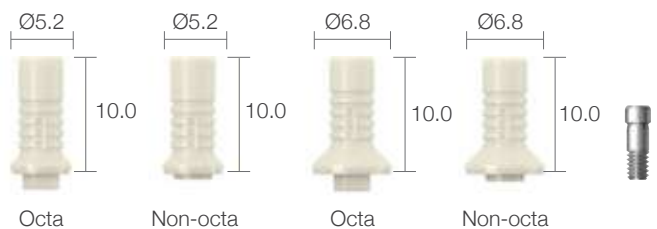

Fixture Analog

Application	Art. No.
Ø4.8	SODAN 48
Ø6.5	SODAN 65



Prosthetic Procedure 3

Impression Technique and Restoration Selection

Screw Abutment

Abutment Level Impression

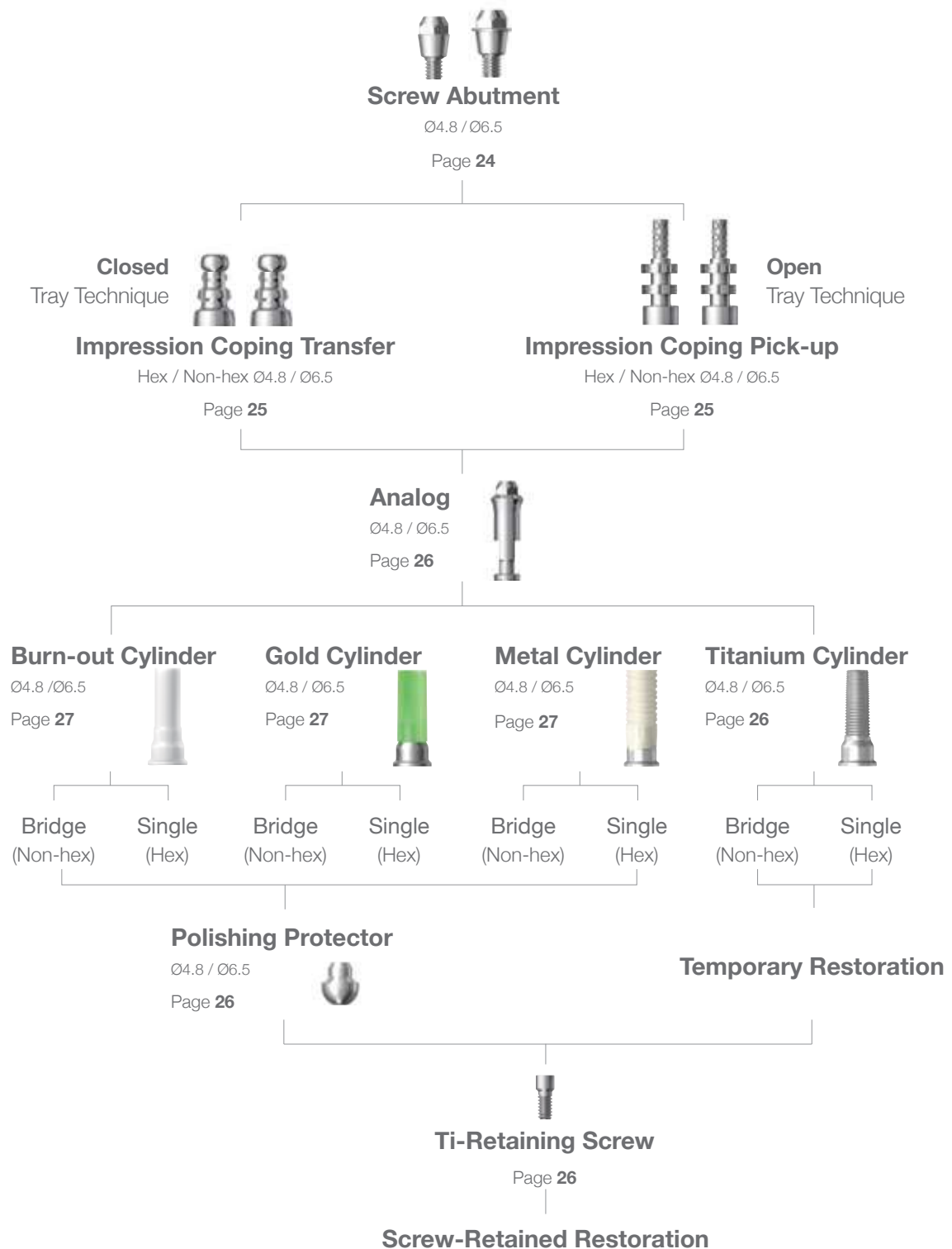

Screw Abutment

Unit:mm, Scale 1: 1.5 / mm



SOSAB4816 and NFX3609S

Screw Abutment

Application	Art. No.
Ø4.8	SOSAB 48 16
Ø6.5	SOSAB 65 16

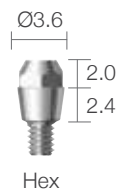

Screw Abutment Impression Components

Unit:mm, Scale 1: 1.5 / mm

Comfort Cap | Plastic

Application	Art. No.
Ø4.8	SOSCC 48 35
Ø6.5	SOSCC 65 35



Comfort Cap | Metal

Application	Art. No.
Ø4.8	SOSCC 48 T
Ø6.5	SOSCC 65 T



Impression Coping Pick-up

Application	Type	Art. No.
Ø4.8	Hex	SOSPU 48 16 H
	Non-Hex	SOSPU 48 16 N
Ø6.5	Hex	SOSPU 65 16 H
	Non-Hex	SOSPU 65 16 N



Impression Coping Transfer

Application	Type	Art. No.
Ø4.8	Hex	SOSTF 48 16 H
	Non-Hex	SOSTF 48 16 N
Ø6.5	Hex	SOSTF 65 16 H
	Non-Hex	SOSTF 65 16 N



Screw Abutment Impression Components

Unit:mm, Scale 1: 1.5 / mm

Impression Coping Screw

Type	Art. No.
Pick-up	SOSPS 09 16
Transfer	SOSTS 09 16

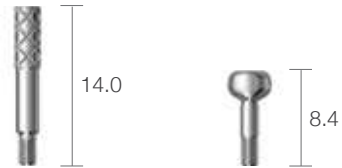

Analog

Application	Art. No.
Ø4.8	SOSAN 48 16
Ø6.5	SOSAN 65 16



Polishing Protector

Application	Art. No.
Ø4.8	SOSPP 48 16
Ø6.5	SOSPP 65 16



Ti-Retaining Screw

Art. No.	SOSRS 16 T
----------	-------------------



Screw Abutment Impression Components

Unit:mm, Scale 1: 1.5 / mm

Ti-Cylinder

Application	Type	Art. No.
Ø4.8	Hex	SOSTC 48 16 HG
	Non-hex	SOSTC 48 16 NG
Ø6.5	Hex	SOSTC 65 16 HG
	Non-hex	SOSTC 65 16 NG

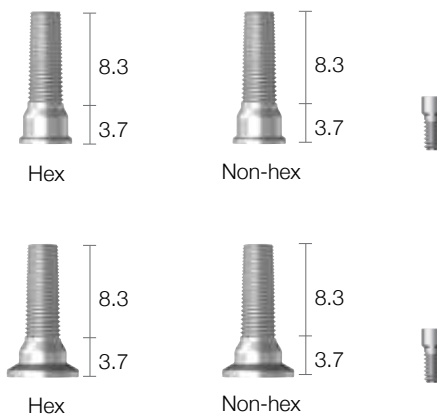

Gold Cylinder

Application	Type	Art. No.
Ø4.8	Hex	SOSGC 48 16 H
	Non-hex	SOSGC 48 16 N
Ø6.5	Hex	SOSGC 65 16 H
	Non-hex	SOSGC 65 16 N

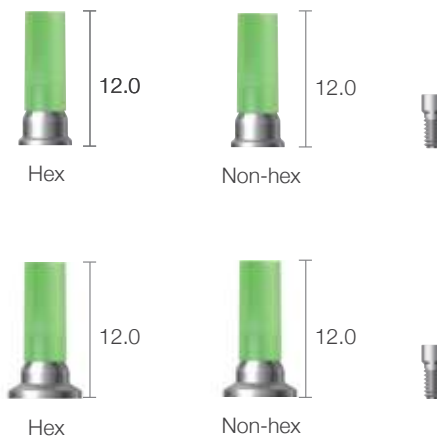

Screw Abutment Impression Components

Unit:mm, Scale 1: 1.5 / mm

Metal Cylinder - Co-Cr

Application	Type	Art. No.
Ø4.8	Hex	SOSGC 48 16 CH
	Non-hex	SOSGC 48 16 CN
Ø6.5	Hex	SOSGC 65 16 CH
	Non-hex	SOSGC 65 16 CN

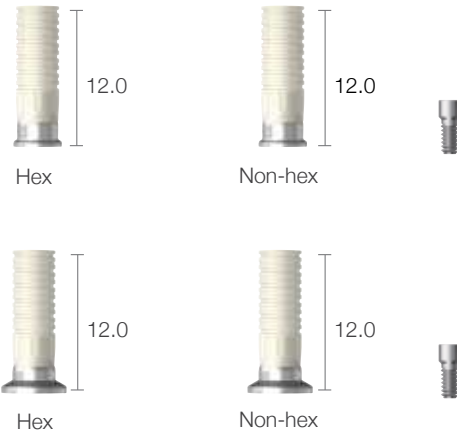

Burn-Out Cylinder

Application	Type	Art. No.
Ø4.8	Hex	SOSBC 48 16 H
	Non-hex	SOSBC 48 16 N
Ø6.5	Hex	SOSBC 65 16 H
	Non-hex	SOSBC 65 16 N



Prosthetic Procedure 4

Impression Technique and Restoration Type

Overdenture Procedure

Positoner / Mini Ball / Magnetic Attachment



Positioner

Ø4.8

Page 29



Mini Ball Abutment

Ø4.8 / Ø6.5

Page 30



Implant Keeper

Ø4.8 / Ø6.5

Page 31

Abutment Level Impression



Positioner Impression Coping

Page 29



Mini Ball Impression Coping

Page 30



Positioner Analog

Page 29



Mini Ball Analog

Page 30



Positioner Block Out Spacer

Page 29



Socket Spacer

Page 30



**Positioner Metal Socket
/ Plastic Socket**

Page 29



Mini Denture Socket and O-ring

Page 30



Magnetic Assay

Page 31

**Positioner Attachment
for Overdenture**

**Mini Ball and Socket Attachment
for Overdenture**

**Magnetic Attachment
for Overdenture**

Positioner Attachment

- Abutment screw is included.

Unit:mm, Scale 1: 1.5 / mm



FSMHS and SOPAB4810 and SOFX483810R

Positioner Abutment

Application	G/H	Art. No.
Ø4.8	0	SOPAB 48 00
	1.0	SOPAB 48 10
Ø6.5	0	SOPAB 65 00
	1.0	SOPAB 65 10

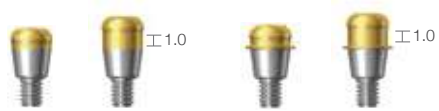

Positioner Impression Coping

PIC



Positioner Analog

PAN



Positioner Socket Set

Art. No.	FSMHS(Tilting Type $\pm 10^\circ$)
	FSMHSN(Non Tilting Type $\pm 5^\circ$)



Positioner Attachment

Unit:mm, Scale 1: 1.5 / mm

Positioner Metal Socket

Art. No.	FSMH
----------	------



Positioner Plastic Socket

Application	Art. No.
Tilting Type ±10°	MSHP (Blue)
	MSMP (Orange)
	MSLP (Ivory)
	MSOP (White)
Non Tilting Type ±5°	MSHPN (Blue)
	MSMPN (Orange)
	MSLPN (Ivory)
	MSOP (White)

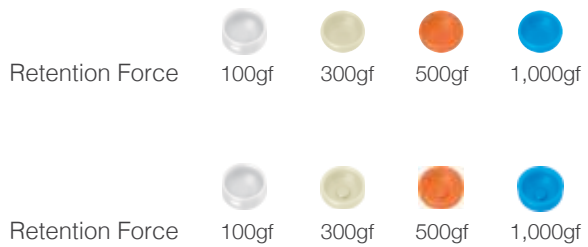

Positioner Block Out Spacer

Art. No.	PBOS
----------	------



Positioner Core Tool

Art. No.	XPCT
----------	------



Mini Ball Attachment

- Abutment screw is included.

Unit:mm, Scale 1: 1.5 / mm



BPF3 and SOBAB4800 and SOFX483810R

Mini Ball Abutment

Application	Art. No.
Ø4.8	SOBAB 48 00
Ø6.5	SOBAB 65 00

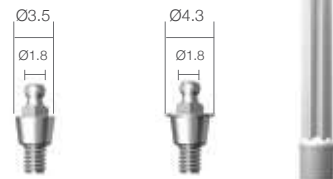

Mini Ball Impression Coping

Art. No.	ICA



Mini Ball Analog

Art. No.	BANL



Socket Spacer

Art. No.	BIC3L



Female Socket

Art. No.	BPF3 (300~500gf) BPF2 (500~700gf)

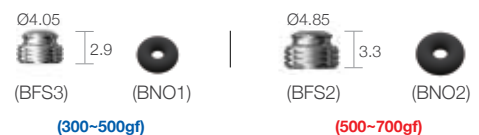

Magnetic Attachment

- Abutment screw is included.

Unit:mm, Scale 1: 1.5 / mm



BPF3 and SOBAB4800 and SOFX483810R

Magnetic Assay

Application	Art. No.
Ø4.8	MGT 45 20 D
Ø6.5	MGT 55 20 D



Implant Keeper

Application	G/H	Art. No.
Ø4.8	2.0	SOMKP 48 20 D
	4.0	SOMKP 48 40 D
Ø6.5	2.0	SOMKP 65 20 D
	4.0	SOMKP 65 40 D

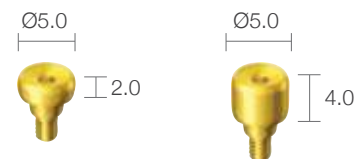

Surgical Kit

Unit:mm, Scale 1: 1.5 / mm

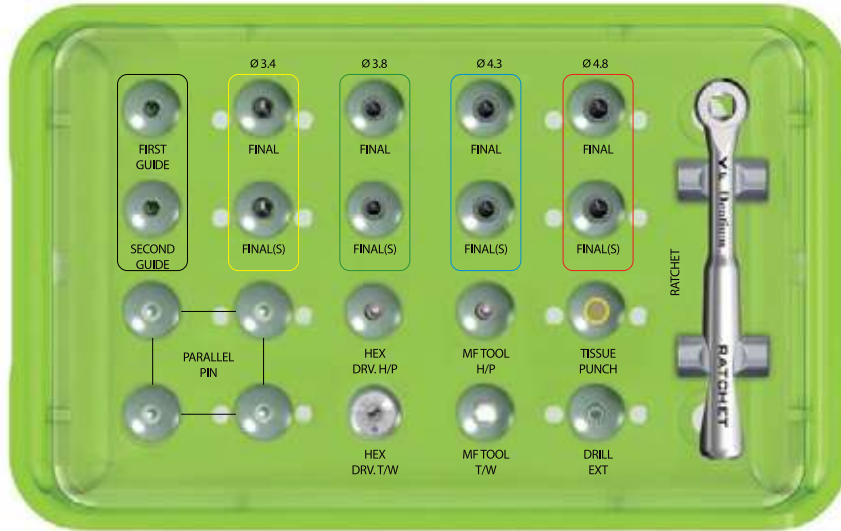

SimpleLine II Surgical Kit

SOXIK

Kit includes

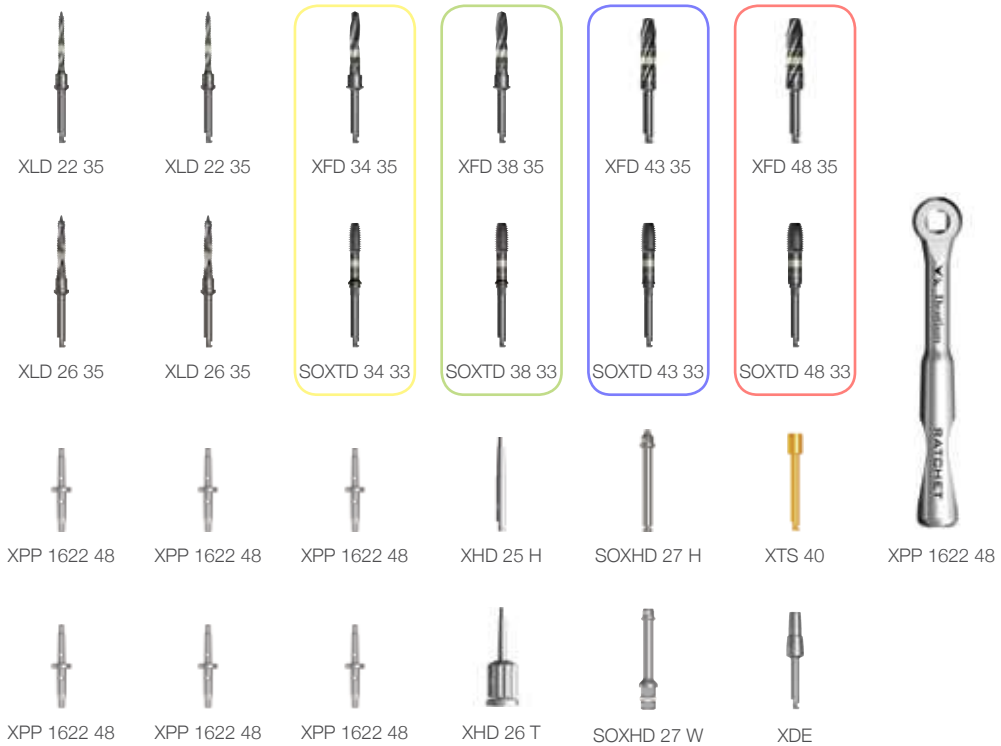

Drill

Unit: mm, Scale 1 : 1 / mm

Guide Drill (First, Second) | Stopper

Diameter	L	Art. No.
Ø2.2	35	XLD 22 35
Ø2.6	35	XLD 26 35
Ø2.2	29	XLD 22 29
Ø2.6	29	XLD 26 29

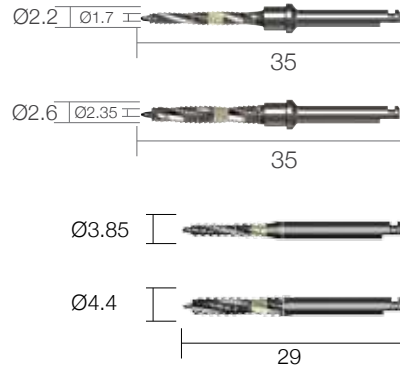

Final Drill

Diameter	L	Art. No.
Ø2.85	35	XFD 34 35
Ø3.3	35	XFD 38 35
Ø3.85	33	XFD 43 33
Ø4.4	33	XFD 48 33
Ø2.85	29	XFD 34 29
Ø3.3	29	XFD 38 29
Ø3.85	29	XFD 43 29
Ø4.4	29	XFD 48 29

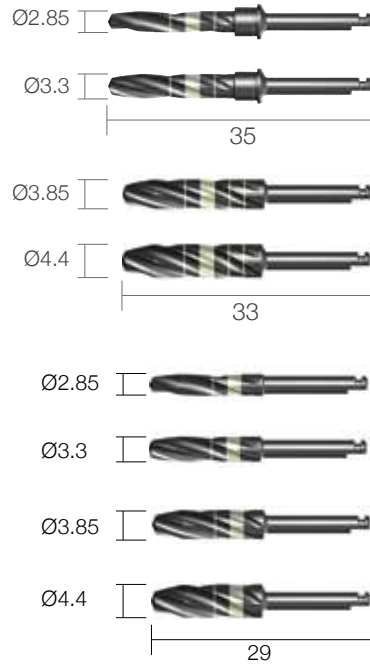

Round Bur

Diameter	L	Art. No.
Ø2.0	33	XRB 20 33
Ø3.0	33	XRB 30 33

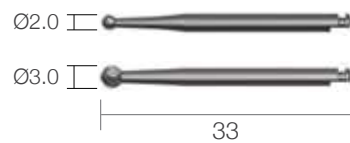

Instrument

Unit: mm, Scale 1 : 1 / mm

Tap Drill Adapter

Art. No.	XRA3917
----------	---------



Adapter

Type	L	Art. No.
Hand-piece	21	SOXHD 21 H
	24	SOXHD 24 H
	27	SOXHD 27 H
Ratchet	21	SOXHD 21 W
	24	SOXHD 24 W
	27	SOXHD 27 W

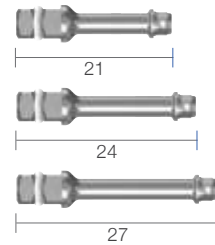
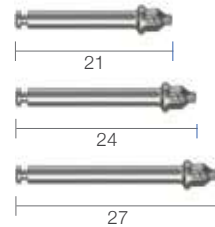

Mount Adapter

Type	L	Art. No.
Hand-piece	19	SOXMA 19
Ratchet	19	SOXRA 19

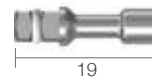
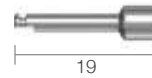

Hex Driver | Hex 1.28 mm

Type	L	Art. No.
Hand-piece	25	XHD 25 H
Manual	26	XHD 26 T

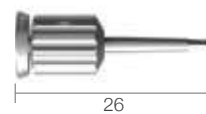
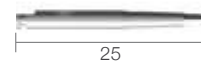

Instrument

Unit: mm, Scale 1 : 1 / mm

Path Pin

L	Art. No.
18.3	SOXMFPAS
23.3	SOXMFPA

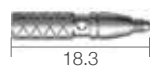

Parallel Pin

Diameter	L	Art. No.
Ø4.8	21.5	XPP1622 48
Ø6.5	21.5	XPP1622 65

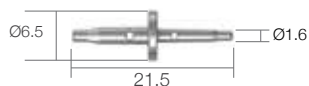
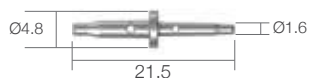

Drill Extension

Art. No.	XDE

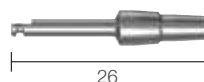

Tissue Punch

Art. No.	XTS 40



※ Hole punched diameter : Ø4.0

Ratchet

Art. No.	XRCA1



Prosthetic Kit

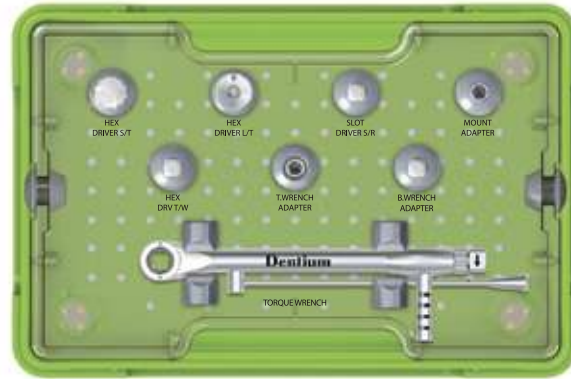

SimpleLine II Prosthetic Kit

XIP

Kit includes



XHD 15



XHD 30 T



SDA 25 R



XMMA 1



XHD 25 W



XMA 21 W



IPST 21 W



XNTW

Prosthetic and Laboratory Instrument

Unit: mm, Scale 1: 1 / mm

Hex Driver | Hex 1.28 mm

L	Art. No.
13	XHD 13
15	XHD 15
21	XHD 21
28	XHD 28

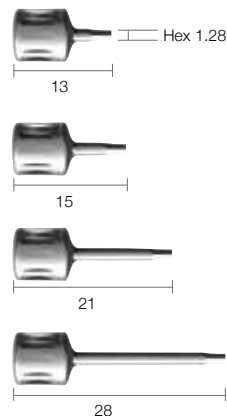

Hex Driver | Hex 1.28 mm

Type	L	Art. No.
Torque Wrench	25	XHD 25 W
Manual	30	XHD 30 T

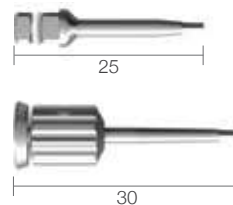

Adapter

Type	L	Art. No.
Hand-piece	21	XMAA 1
Torque Wrench	21	XHD 21 W
Mini Ball	21	IPST 21 W

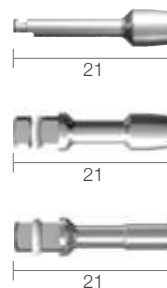

Slot Driver

Art. No.	SDA 25 R
----------	----------



Torque Wrench | Scale 1 : 0.7 / mm

Art. No.	XNTW
----------	------



Prosthetic and Laboratory Instrument

Unit: mm, Scale 1: 1 / mm

Reamer Guide | Solid / Dual Abutment

Application	Art. No.
Ø4.8	OISRG 48
Ø6.5	SOSRG 65

Ø4.8 Ø6.5 

Reamer Guide | SCA Abutment

Application	Art. No.
Ø4.8	CRG 55 L
Ø6.5	CRG 65 L

Ø4.8 Ø6.5 

Reamer Guide | Screw Abutment

Application	Art. No.
Bridge	SOSRG BL
Single	SOSRG SL

Bridge Single 

Reamer | Solid / Dual / Screw Abutmen

Application	Art. No.
Ø4.8	OISRM
Ø6.5	SOSRM 65



Reamer | SCA Abutment

Art. No.	CRM



Reamer Handle | Scale 1 : 0.5 / mm

Art. No.	CRH





SURGICAL MANUAL

Surgical Drill Sequence	45
Fixture Installation	46
Fixture Connection	46
Surgical Kit Maintenance	47
Warnings	48

Surgical Drill Sequence

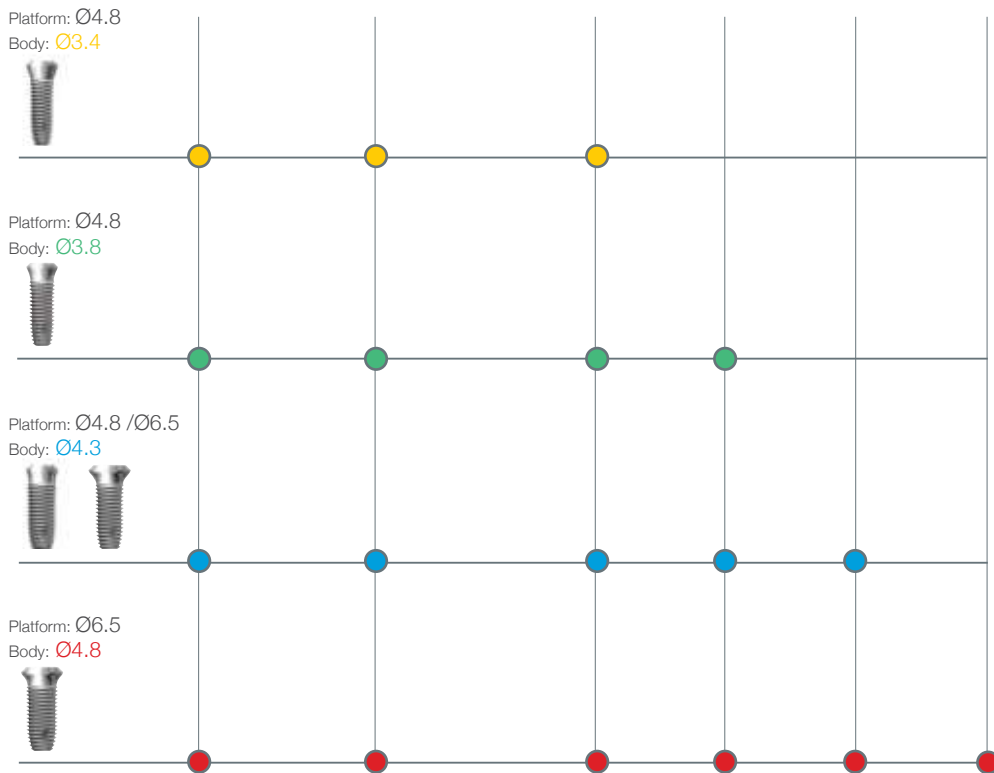
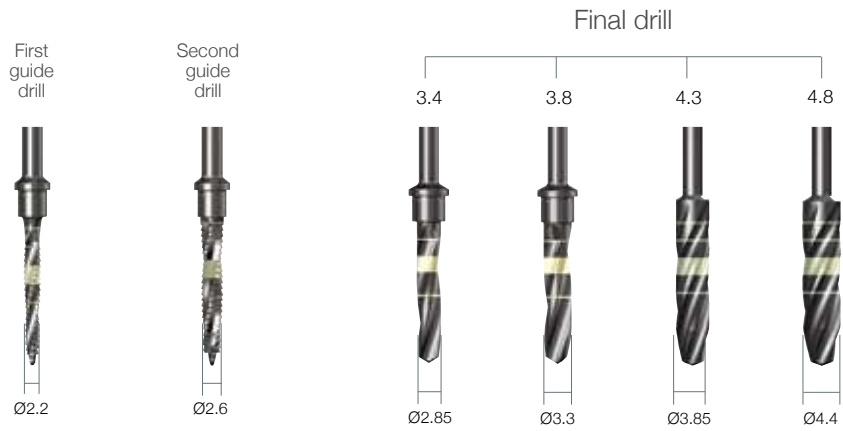
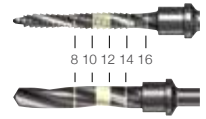

Fixture Installation

Platform: Ø6.5 / Body: Ø4.8 (800~1,200rpm / 30~45N-cm)

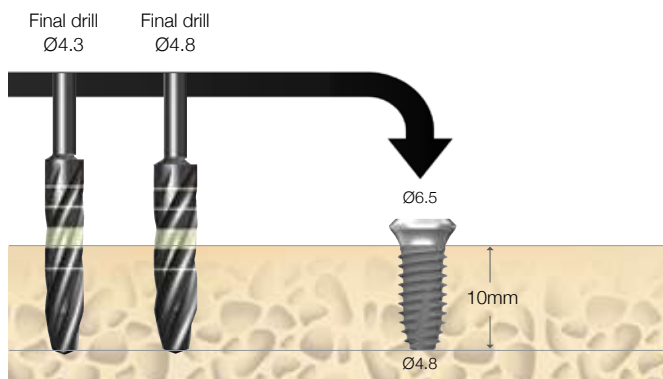

Fixture Connection



Caution_ When opening the fixture package, hold it upright to avoid falling out of the fixture. Securely engage the adapter with the fixture.



By hand-piece
20rpm / 35N-cm



By ratchet



Directions when Using the Hand-piece / Ratchet Adapter

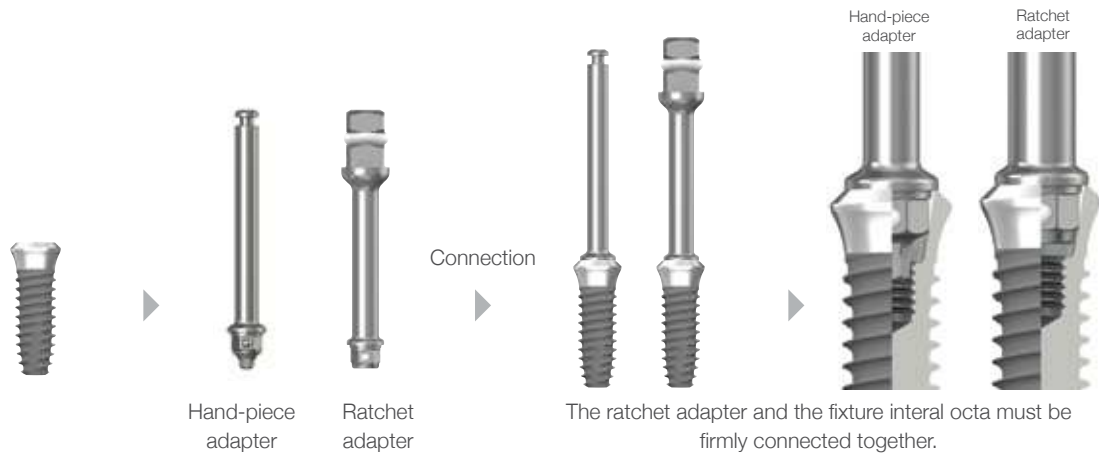

Surgical Kit Maintenance

Sterilization and Instrument Care Procedures

- Please follow legal regulations, as well as hygienic guidelines to prevent contamination and infection.
 - Please remember that you are responsible for the maintenance and sterilization of your medical / dental products/devices. It is important to use and follow proper cleaning, disinfection and sterilization procedures.
 - It is also important to follow the manufacture's recommendation on the usage of the drills.. Please keep a log as to the number of times the drills are used.
 - Drills are used per implant placed not per patient. Bone density determines the longevity of the drills.
 - Replace white and red o-rings on the adapters and the hex drivers, if worn and dried out.
 - Drills should be considered for replacement after about 40 uses based on bone density.
- 01 All instruments, immediately after use, must be pre-soaked for a few minutes in a germicidal bath to loosen and prevent debris from attaching to instruments. Do not soak over-night.
 - 02 Scrub with a soft brush to remove any debris.
 - 03 For internal irrigation drills use a reamer or small gauge needle to cleanout drill internally.
 - 04 If using an ultrasonic cleaner, wrap drills in a 2 x 2 gauze to prevent the drills from rubbing against each other.
 - 05 Rinse thoroughly under warm water.
 - 06 Clean all instrument trays with a germicidal cleaner prior to replacing instruments in kit.
 - 07 Dry completely and place back into kit.
 - 08 Always check for damage or corrosion after rinsing and drying.
 - 09 Seal the tray in a sterilization pouch.
 - 10 Sterilize using a steam autoclave at 121°C / 250°F for 30 minutes or refer to manufacture's recommendations.
 - 11 Store in a dry area at room temperature.

Maintenance Period for Surgical Drills

All surgical drills should be replaced after approximately 40 uses based on bone density

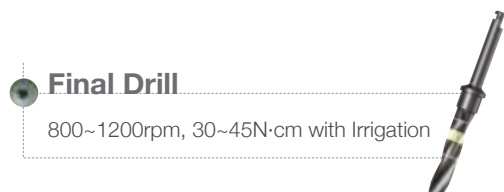
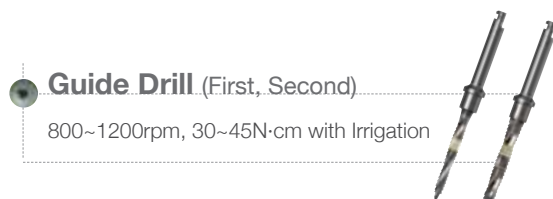

Warnings

Warnings

Dental implant surgery and restoration involve complex dental procedures. Appropriate and adequate training in proper technique is strongly recommended prior to use.

- Improper medical examination and / or treatment plan can result in implant failure and / or loss of supportive bone.
- Improper initial stability and / or excessive occlusal forces during healing period may lead to osseointegration failure.
- Excessive insertion torque may lead to a mechanical failure or a implant biologic failure due to bone compression and necrosis.
- When forces or loads are greater than its design, implant or abutment fracture could occur. Therefore clinicians should make careful decisions in regards to clinical treatment planning to minimize the risk of fracture. Appropriate implant quantity, occlusal interface and a nightguard are essential. Potential excessive loading conditions may include the following:

- 01** Inadequate number of implants are placed.
- 02** Implant width and / or length are inappropriate for a treatment site.
- 03** Prosthesis which has excessive cantilever length due to inadequate biomechanical design.
- 04** Continuous occlusal force may be generated by incomplete connection between implant and abutment and / or abutment screw loosening.
- 05** Direct casting abutment angles are greater than 30°w from the vertical axis of the implant.
Angled abutment is excessively milled.
- 06** Occlusal interferences causing excessive lateral forces.
- 07** Patient parafunctions such as bruxism.
- 08** Inadequate dental laboratory casting procedures.
- 09** Improper prosthesis fit.
- 10** Trauma from patient habits or accidents.
- 11** Excessive marginal bone loss caused by inadequate bone width and / or advanced periimplantitis.

PROSTHESIS MANUAL

Types of Abutment	50
Prosthetic Procedure 1	51
Abutment Level- Solid / Dual Abutment	52
Abutment Level- SCA Abutment	55
Prosthetic Procedure 2	58
Fixture Level [Pick-up Type]- Dual Abutment	59
Fixture Level [Transfer Type]- Dual Abutment	62
Fixture Level- SCA Abutment	65
Fixture Level- Dual Milling Abutment	67
Fixture Level- Angled Abutment	69
Fixture Level- Direct Casting Abutment	71
Prosthetic Procedure 3	73
Abutment Level- Screw Abutment	74
Cementation Repair Method (SCRIP)	74
Prosthetic Procedure 4	79
Positioner	80
Ball Attachment	82
Magnetic Attachment	84

Types of Abutment

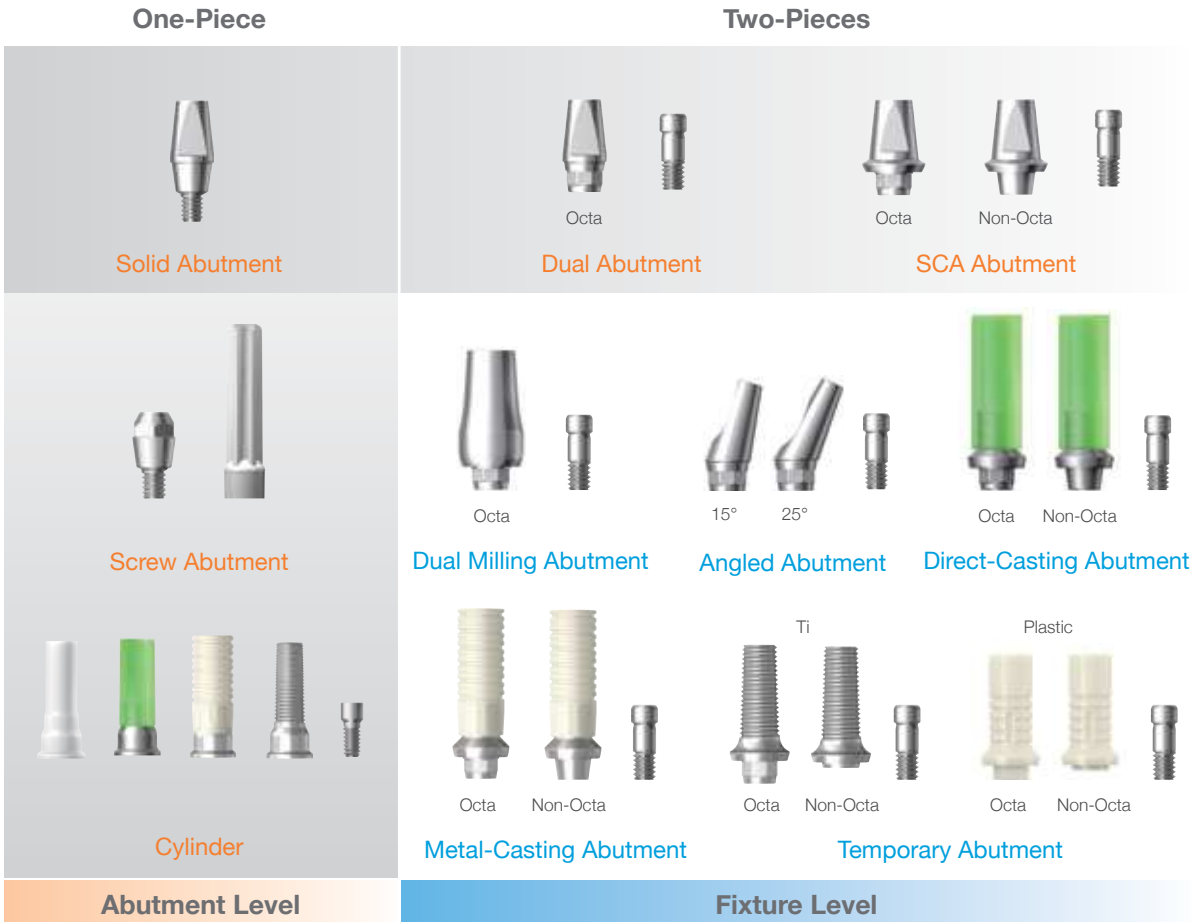

- Dual Abutment
- Solid Abutment
- SCA Abutment

- Dual Abutment
- SCA Abutment
- Dual Milling Abutment
- Angled Abutment (15°/25°)
- Direct-Casting Abutment
- Metal-Casting Abutment
- Temporary Abutment

- Screw Abutment

- Positioner
- Ball
- Magnetic

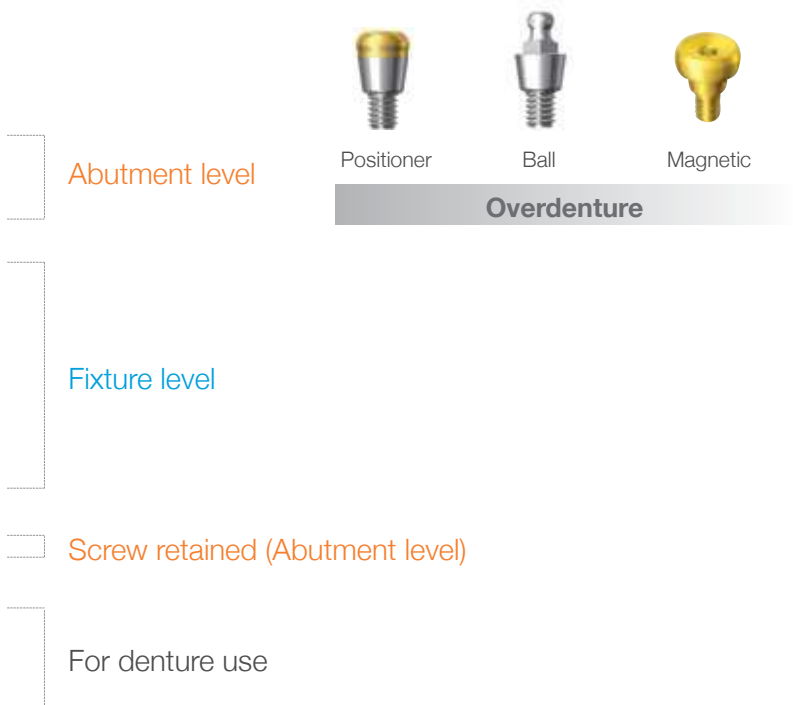

Prosthetic Procedure 1

Impression Technique and Restoration Selection

Solid / Dual / SCA Abutment

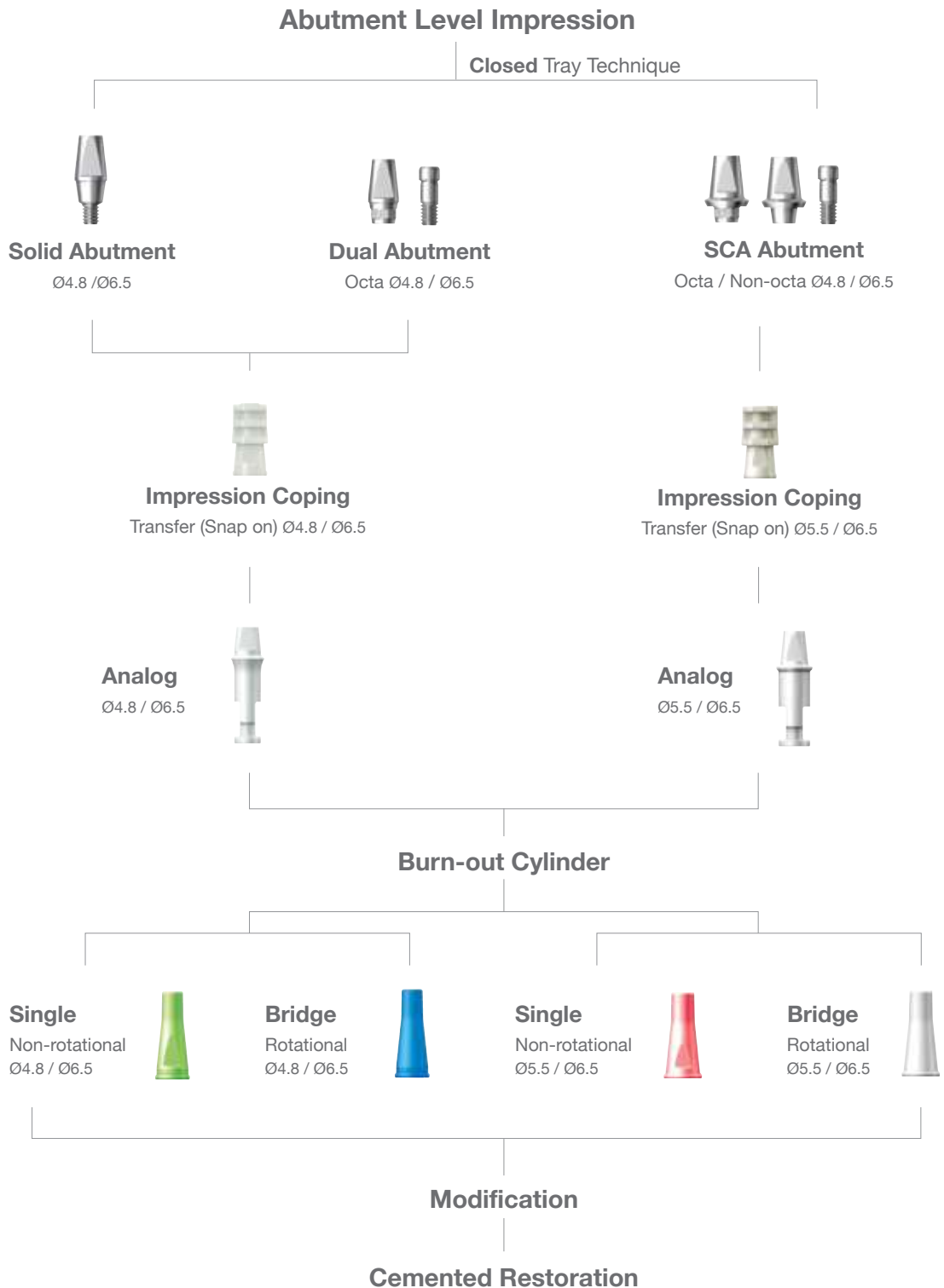

Abutment Level- Solid / Dual Abutment

[Multiple Units]

Clinical Procedure



Chairside

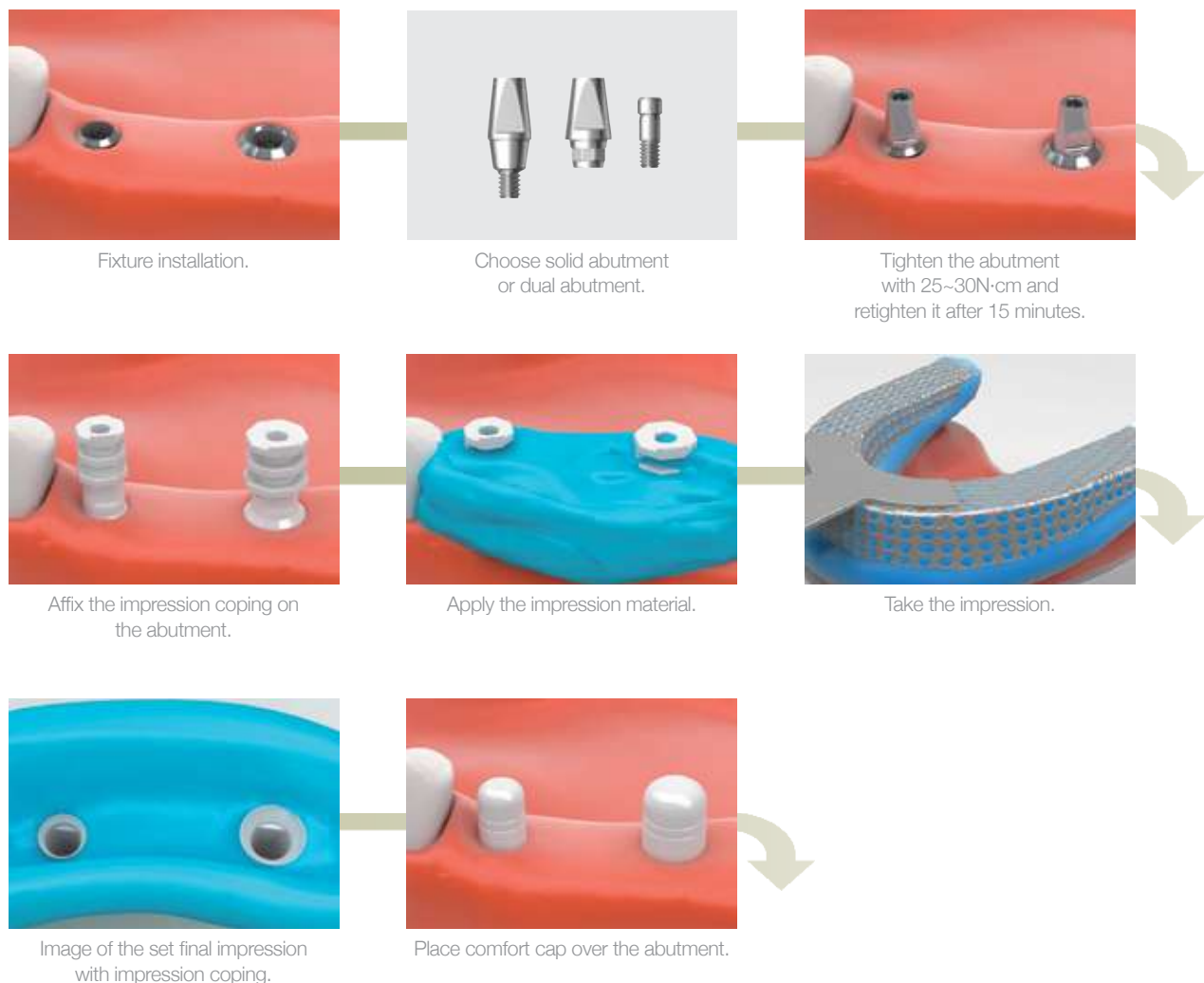

Abutment Level- Solid / Dual Abutment

[Multiple Units]

Laboratory Procedure



Lab Side

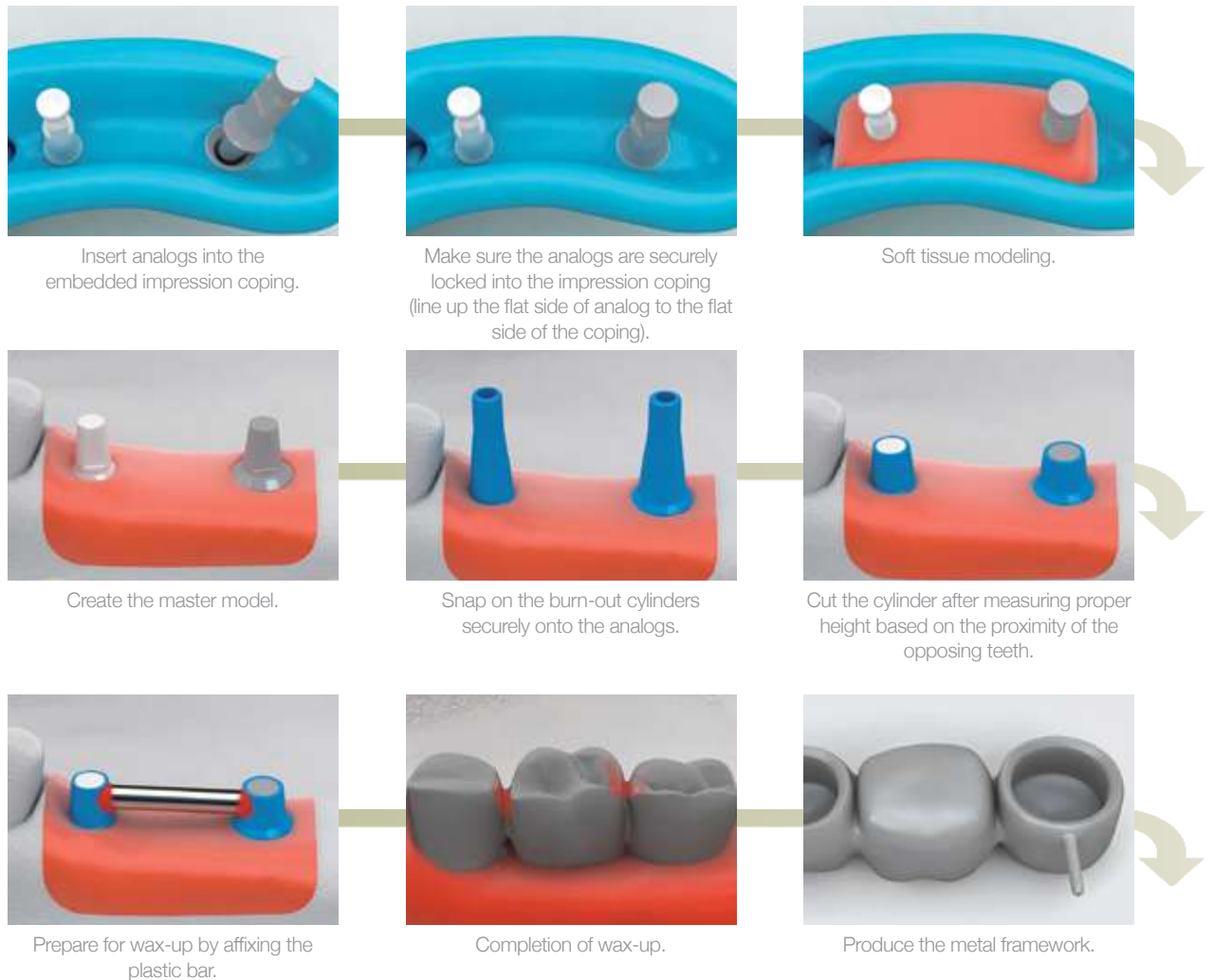

Abutment Level- Solid / Dual Abutment

[Multiple Units]



Shave off the extended margin by using the rubber wheel.



Metal framework and reamer.



Use the reamer to eliminate the "Lip" created by the "snap-on" mechanism.



Metal Framework after the removal of the "Lip".



Metal framework.



Porcelain build-up.

[Only Dual Abutment]

SCRIP : Once an access hole has been created, it could be converted to a SCRIP (Screw & Cement Retained Prosthesis).



Final prosthesis.



Create an access hole when the burn-out cylinder is used for the wax-up.



Image of the extended margin around the metal framework.



Shave off the extended margin by using the rubber wheel.



Metal framework and reamer.



Use the reamer to eliminate the "Lip" created by the "snap-on" mechanism.



Metal framework after the removal of the "Lip".



Metal framework.



Final prosthesis.

Abutment Level- SCA Abutment

[Multiple Units]

Clinical Procedure



Chairside



Fixture installation.



Choose SCA abutment (Octa / Non-octa).



Tighten the abutment with 25~30N-cm and retighten it after 15 minutes.



Affix the impression coping on the abutment.

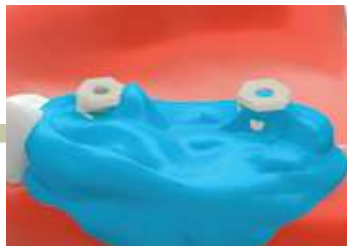

Apply the impression material.

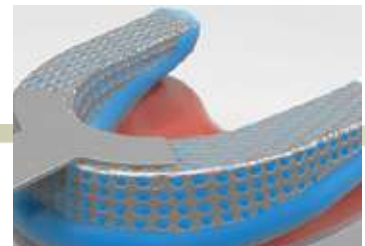

Take the impression.



Image of the set final impression with impression coping.



Place comfort cap over the abutment.

Abutment Level- SCA Abutment

[Multiple Units]

Laboratory Procedure

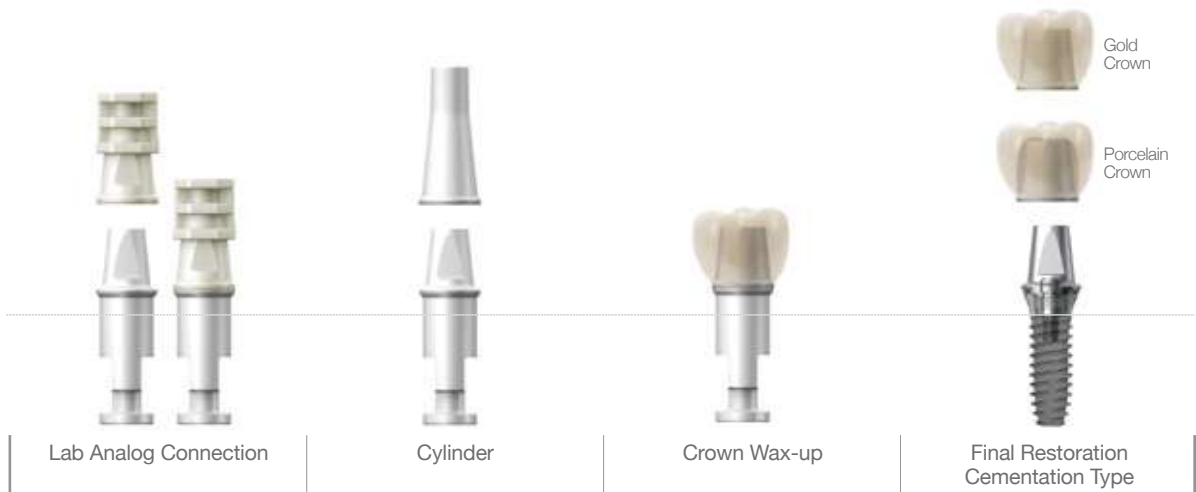

Lab Side



Insert analogs into the embedded impression coping.



Make sure the analogs are securely locked into the impression coping (line up the flat side of analog to the flat side of the coping).



Soft tissue modeling.



Create the master model.



Snap on the burn-out cylinders securely onto the analogs.



Cut the cylinder after measuring proper height based on the proximity of the opposing teeth.



Prepare for wax-up by affixing the plastic bar.



Completion of wax-up.



Produce the metal framework.

Abutment Level- SCA Abutment

[Multiple Units]



Shave off the extended margin by using the rubber wheel.



Metal framework and reamer.



Use the reamer to eliminate the "Lip" created by the "snap-on" mechanism.



Metal Framework after the removal of the "Lip".



Metal framework.



Porcelain build-up.

SCRIP : Once an access hole has been created, it could be converted to a SCRIP (Screw & Cemented Retained Prosthesis).



Final prosthesis.



Create an access hole when the burn-out cylinder is used for the wax-up.



Image of the extended margin around the metal framework.



Shave off of the extended margin by using the rubber wheel.



Metal framework and reamer.



Use the reamer to eliminate the "Lip" created by the "snap-on" mechanism.



Metal framework after the removal of the "Lip".



Metal framework.



Final prosthesis.

Prosthetic Procedure 2

Impression Technique and Restoration Selection

**Dual / SCA / Dual Milling / Angled / Direct-Casting /
Metal-Casting / Temporary Abutment**

Fixture Level Impression

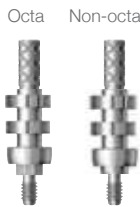

Impression Coping / Pick-up
Open tray technique (Complicated case)
Ø4.8 / Ø6.5



Impression Coping / Transfer
Closed tray technique (Simple case)
Ø4.8 / Ø6.5



Analog
Ø4.8 / Ø6.5



Modification

Cemented Restoration

Modification

Screw-Retained Restoration

Fixture Level [Pick-up Type]- Dual Abutment

[Multiple Units]

Clinical Procedure

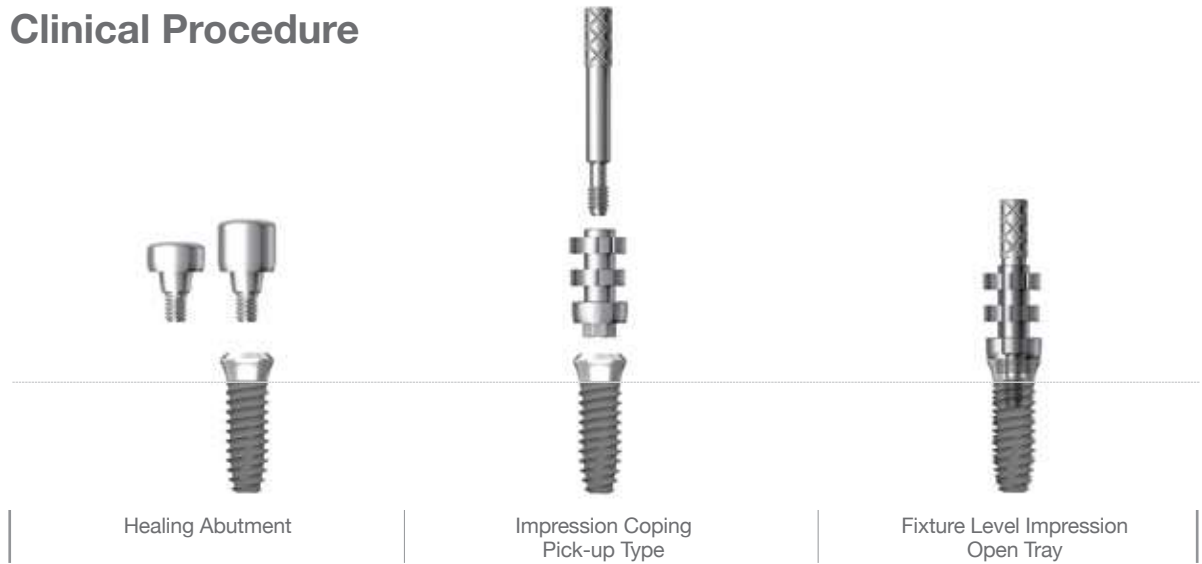

Chairside

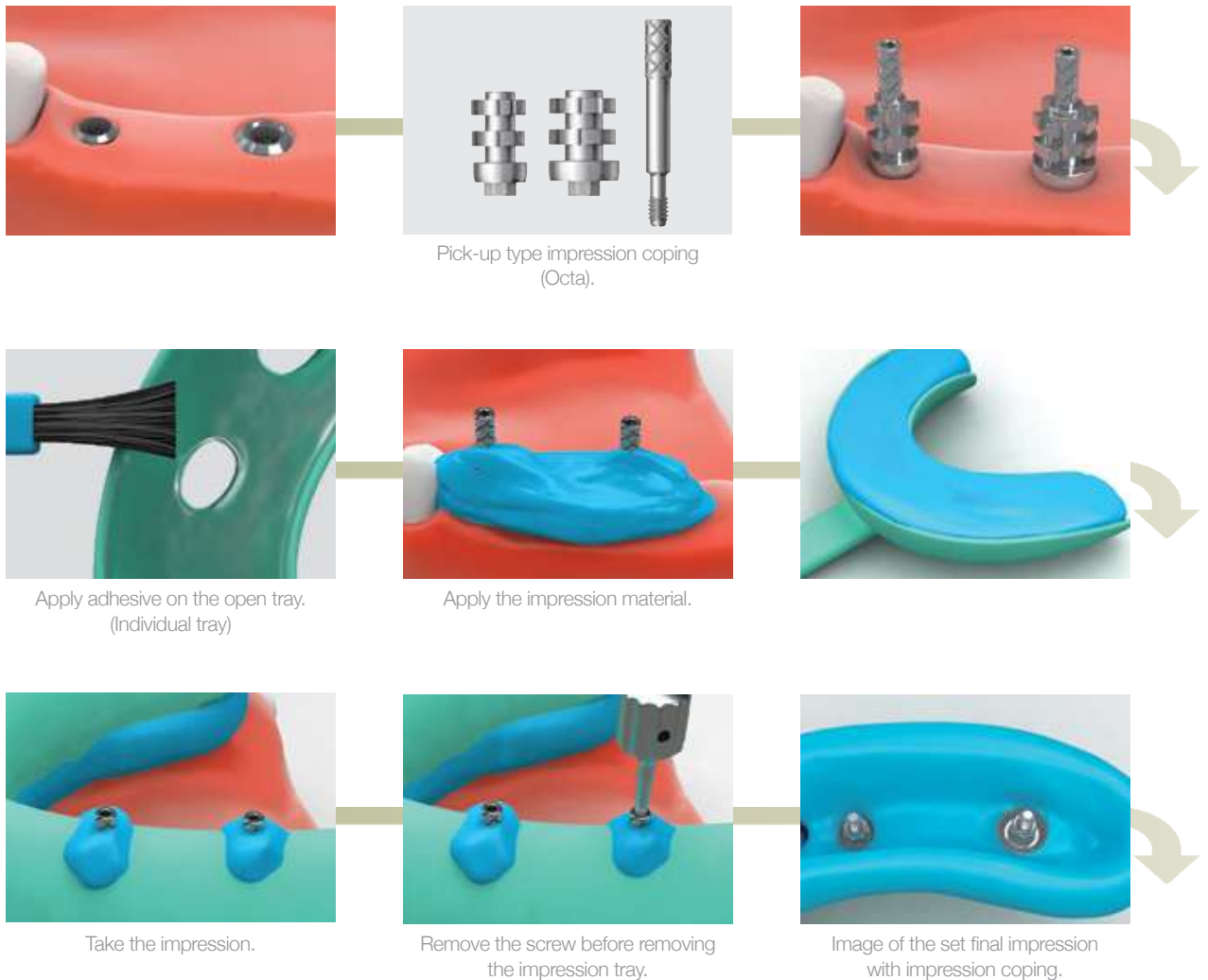

Fixture Level [Pick-up Type]- Dual Abutment

[Multiple Units]

Laboratory Procedure



Lab Side



Connect analogs with the embedded impression coping.



Soft tissue modeling.



Create the master model.



Assemble the dual abutment.



If deemed necessary, abutment milling is possible.



Fabricate the positioning jig



Fabricate the cap with pattern resin.



Completion of wax-up.



Metal framework.

Fixture Level [Pick-up Type]- Dual Abutment

[Multiple Units]



Final prosthesis.

Chairside



Use positioning jig to transfer the abutment from the model to the intraoral and then tighten it with 25~30N·cm.
Re-tighten it after 15 minutes.



Cement the final prosthesis and make occlusal adjustment.

* In the process of seating the prosthesis, the components can be rebounded by gingival tissue. In that case, it is advised to apply occlusal load on the prosthesis for 10~15 minutes.

SCR- Lab Side



Create an access hole for pick-up coping screw.



Completion of Wax-up.



Metal framework.



Final prosthesis.

SCR- Chairside



Use positioning jig to transfer the abutment from the model to the intraoral and tighten with to 25~30N·cm.
Re-tighten it after 15 minutes.



Cement the final prosthesis and make occlusal adjustment.

* In the process of seating the prosthesis, the components can be rebounded by gingival tissue. In that case, it is advised to apply occlusal load on the prosthesis for 10~15 minutes.

Fixture Level [Transfer Type]- Dual Abutment

[Multiple Units]

Clinical Procedure



Chairside

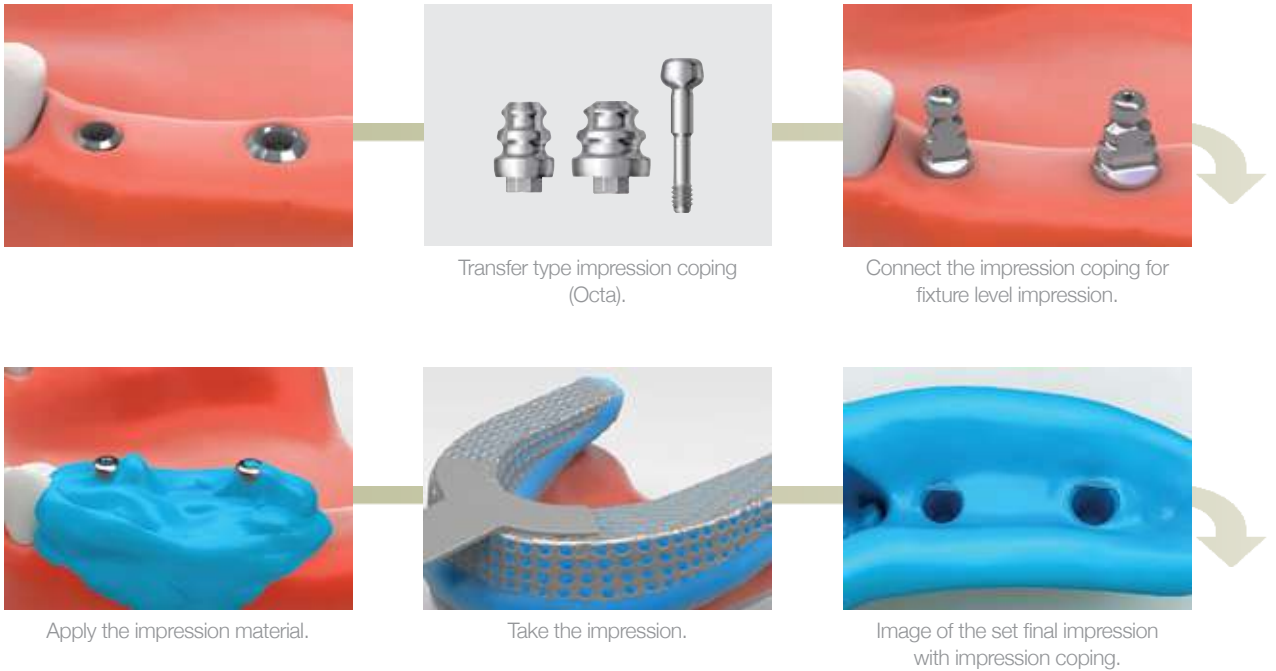

Fixture Level [Transfer Type]- Dual Abutment

[Multiple Units]

Laboratory Procedure



Lab Side



Impression coping and analog connection. And insert impression coping into the impression.



Make sure the analogs are securely seated in the impression coping (line up the flat side of analog to the flat side of the coping).



Soft tissue modeling.



Create the master model.



Examine the soft tissue condition after the retrieval of the impression coping.



Assemble the dual abutment.

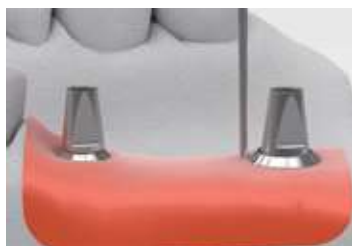

If deemed necessary, abutment milling is possible.



Fabricate the positioning jig.



Fabricate the cap with pattern resin.

Fixture Level [Transfer Type]- Dual Abutment

[Multiple Units]



Completion of wax-up.



Metal framework.



Final prosthesis build-up on the framework with porcelain.

Chairside



Use the positioning jig to transfer the abutment from the model to the intraoral and tighten it with 25~30N-cm. Re-tighten after 15 minutes.



Cement the final prosthesis and make occlusal adjustment. Place wax into the opening of the abutment to protect the screw head prior to the composite sealing.

SCRP- Lab Side



Create an access hole for the pick-up coping screw.



Completion of Wax-up.



Metal framework.

SCRP- Chairside



Final prosthesis.



Use positioning jig to transfer abutment from the model to the intraoral and tighten it with 25~30N-cm. Re-tighten after 15 minutes.



Cement the final prosthesis and make occlusal adjustment. Place wax into the opening of the abutment to protect the screw head prior to the composite sealing.

* In the process of seating the prosthesis, the components can be rebounded by gingival tissue. In that case, it is advised to apply occlusal load on the prosthesis for 10~15 minutes.

Fixture Level- SCA Abutment

[Multiple Units]

Clinical Procedure



Laboratory Procedure



Lab Side



Connect analogs with the embedded impression coping.



Soft tissue modeling.



Create the master model.

Fixture Level- SCA Abutment

[Multiple Units]



Assemble the SCA abutment.



If deemed necessary, abutment milling is possible.



Fabricate the positioning jig



Fabricate the cap with pattern resin



Completion of wax-up.



Metal framework.



Final prosthesis.



Use positioning jig to transfer the abutment from the model to the intraoral and tighten it with 25~30N-cm. Re-tighten it after 15 minutes.



Cement the final prosthesis and make occlusal adjustment. Place wax into the opening of the abutment to protect the screw head prior to the composite sealing.

* In the process of seating the prosthesis, the components can be rebounded by gingival tissue. In that case, it is advised to apply occlusal load on the prosthesis for 10~15 minutes.

SCRP- Lab Side



Create an access hole for pick-up coping screw



Completion of wax-up.



Metal framework.



Final prosthesis.



Use positioning jig to transfer the abutment from the model to the intraoral and tighten it with 25~30N-cm. Re-tighten it after 15 minutes.



Cement the final prosthesis and make occlusal adjustment. Place wax into the opening of the abutment to protect the screw head prior to the composite sealing.

* In the process of seating the prosthesis, the components can be rebounded by gingival tissue. In that case, it is advised to apply occlusal load on the prosthesis for 10~15 minutes.

SCRP-Chairside

Fixture Level- Dual Milling Abutment

[Single Unit]

Clinical Procedure

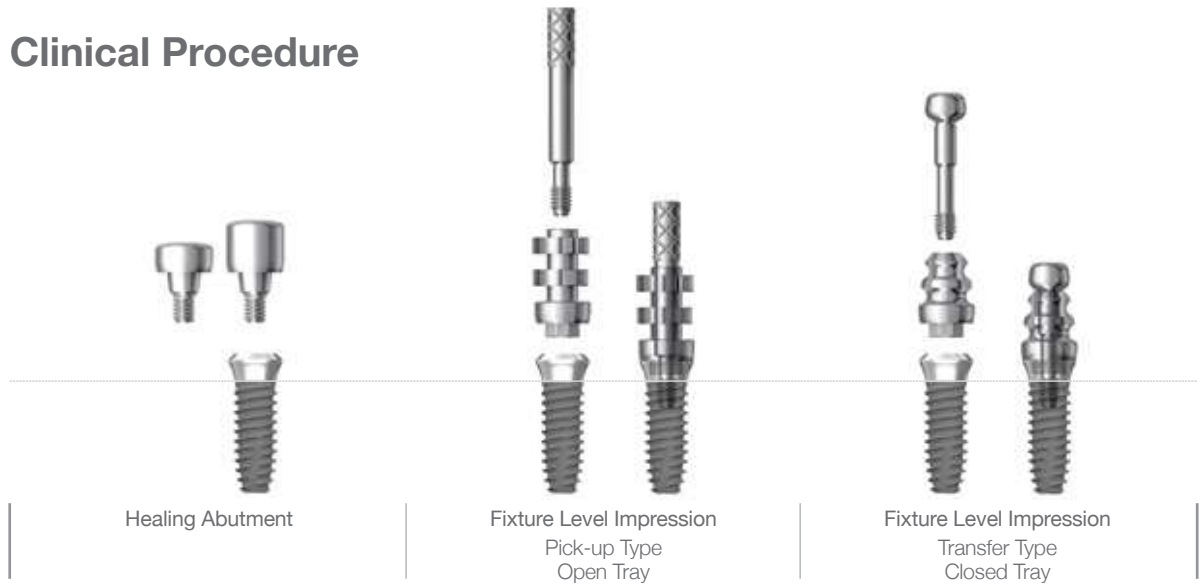

Laboratory Procedure



Lab Side



Connect analogs with the set impression material.



Soft tissue modeling.



Create the master model.

Fixture Level- Dual Milling Abutment

[Single Unit]



Assemble the dual milling abutment.



Milled the abutment to an appropriate size.



Fabricate the positioning jig



Fabricate the cap with pattern resin.



Completion of wax-up.



Metal framework.

Chairside



Final prosthesis.



Use positioning jig to transfer the abutment from the model to the intraoral and tighten it with 25~30N-cm. Re-tighten it aAfter 15 minutes.



Cement the final prosthesis and make occlusal adjustment. Place wax into the opening of the abutment to protect the screw head prior to the composite sealing.

* In the process of seating the prosthesis, the components can be rebounded by gingival tissue. In that case, it is advised to apply occlusal load on the prosthesis for 10~15 minutes.

Fixture Level- Angled Abutment

[Single Unit]

Clinical Procedure



Laboratory Procedure



Lab Side

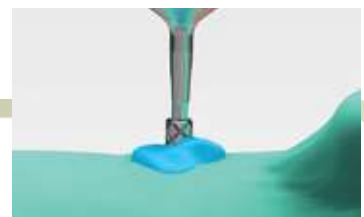

Fixture Level- Angled Abutment

[Single Unit]



Create the master model.



Assemble the angled abutment.



Milled the abutment to an appropriate size and fabricate the positioning jig.



Fabricate the cap with pattern resin.

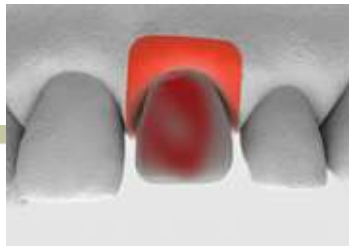

Completion of wax-up.



Metal or zirconia framework.

Chairside



Final prosthesis.



Use positioning jig to transfer the abutment from the model to the intraoral and tighten it with 25~30N-cm. Re-tighten it after 15 minutes.



Cement the final prosthesis and make occlusal adjustment. Place wax into the opening of the abutment to protect the screw head prior to the composite sealing.

Fixture Level- Direct-Casting Abutment

[Single Unit]

Clinical Procedure



Laboratory Procedure



Lab Side



Impression coping with analog connections.



Soft tissue formation and fabrication of master model.

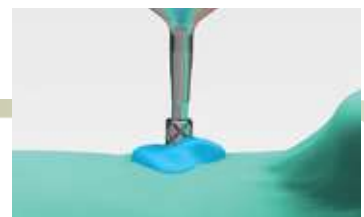

Unscrew and separate the impression from the model.

Fixture Level- Direct-Casting Abutment

[Single Unit]

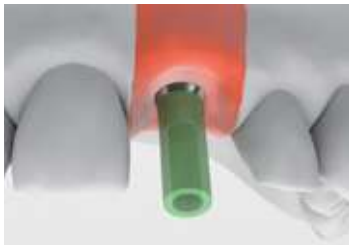

Assemble the direct casting abutment.



Completed customized abutment.



Fabricate the positioning jig.



Fabrication of pattern resin cap

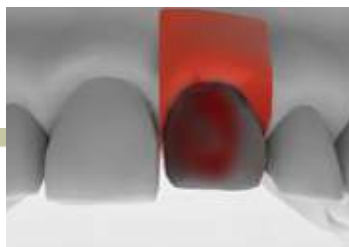

Completion of wax-up.



Metal or zirconia framework.

Chairside



---Final prosthesis.



Use positioning jig to transfer the abutment from the model to the intral and tighten it with 25~30N-cm. Re-tighten it after 15 minutes.



Cement the final prosthesis and make occlusal adjustment. Place wax into the opening of the abutment to protect the screw head prior to the composite sealing.

Fixture Level- Temporary Abutment

[Multiple Units]



Ti-Temporary Abutment

Plastic Temporary Abutment

<Using Ti Abutment>



Consider the opposing teeth before seating the temporary abutment. Trim off the abutment as needed and complete the temporary abutment prosthesis with direct resin.

<Using Plastic Abutment>



Prosthetic Procedure 3

Impression Technique and Restoration Selection

Screw Abutment

Abutment Level Impression

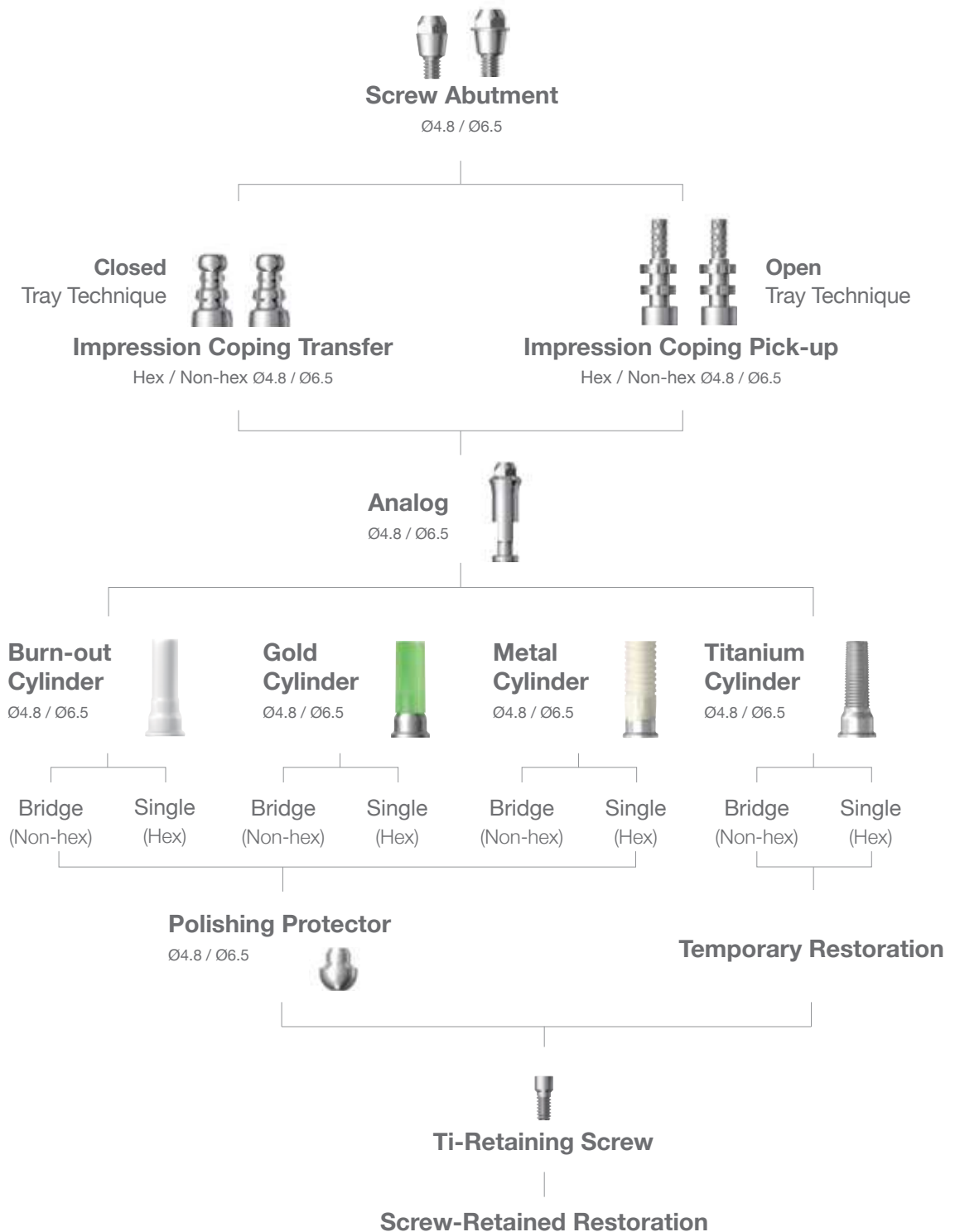

Abutment Level- Screw Abutment

[Multiple Units]

Clinical Procedure

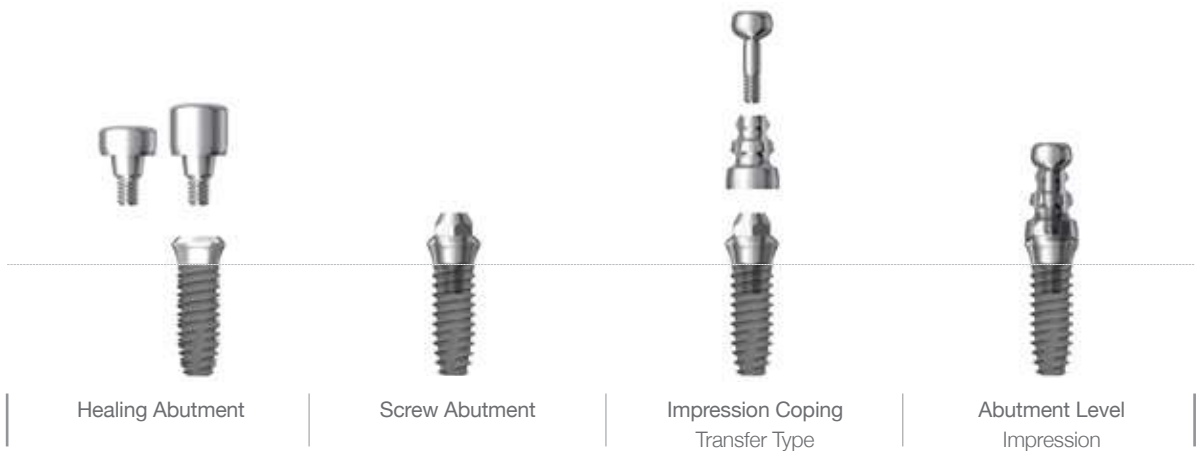

Chairside



Screw abutment and delivery holder.



Select and seat an appropriate screw abutment with delivery holder.



Tighten it with 25~30N-cm. Re-tighten it after 15 minutes with screw abutment adapter.

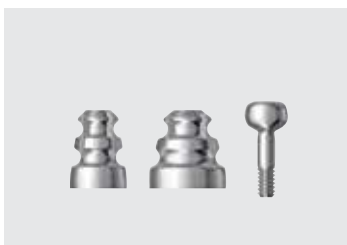

Screw abutment transfer copings (abutment level).



Connect the impression coping for abutment level impression.



Apply the impression material.

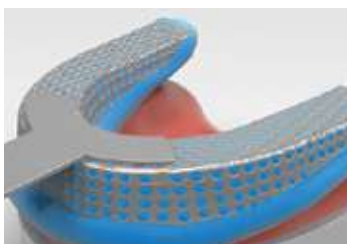

Take the impression.



Image of the set final impression with impression coping.



Place comfort cap over the screw abutment.

Abutment Level- Screw Abutment

[Multiple Units]

Laboratory Procedure



Lab Side



Insert analogs into the set impression.



Make sure the analogs are securely seated in the impression coping (line up the flat side of analog to the flat side of the coping).



Soft tissue modeling.



Create the master model.



Remove the impression coping.



Connect the screw abutment cylinder and tighten it with Ti-retaining screw.



Trim cylinder after measuring proper height based on the proximity of the opposing teeth..

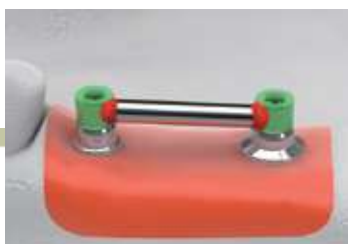

Connect the plastic bar in the middle of trimmed burn-out cylinders to help support the wax pattern.
Wax pattern may experience shrinkages.



Completion of wax-up.

Abutment Level- Screw Abutment

[Multiple Units]



Gold framework.



Use the reamer to remove the "Lip" in the interior of the metal framework.



Completion of gold framework.



Final prosthesis.



Insert the final prosthesis and make necessary occlusal adjustments. Tighten it with ti-retaining screw (10 N·cm).

Cementation Repair Method (SCRIP)

[Screw & Cement Retained Prosthesis]

In light of Implant Prosthesis:

- Screw type restoration simplifies prosthetic repair or insertion and removal of the prosthesis to any given situation.
- Cement type restoration tend to have a stable occlusion and may enhance the adaptability.
However the weak point is, it cannot be removed after permanent cementation.
- A SCA abutment can be cemented or screw retained.
- Solid abutments are cement retained and no occlusal hole is necessary.

Screw Loosening or Prosthesis Repair



In case of the following:
screw loosening or
prosthesis repair



In order to unscrew, create access
hole on the occlusal surface with a bur.



Unscrew, and remove the prosthesis
from the patient's mouth.



Both cemented prosthesis and
abutments are removed.



Finish the repair and seat it inside
the patient's mouth.



Tighten the prosthesis with
25~30N-cm with a screw driver
* It is recommended that the abutment screw is
retightened after 15 minutes.



Place a small piece of cotton
to cover the head of the screw.



Fill the remaining access space with
a resin.



Final prosthesis.

Cementation Repair Method (SCRIP)

[Screw & Cement Retained Prosthesis]

Separation of Prosthesis with Abutment due to Cement Loss



Remove the screw completely with screw driver and remove prosthesis from the patient's mouth.



Apply cement to the prosthesis.



Place it back into the patient's mouth.

* In case of screw abutment connection, Ti-Retain screw has to be tightened with 10N-cm.



Unscrew and remove the excessive cement.



Finish the repair and seat it inside the patient's mouth.



Tighten the prosthesis with 25~30N-cm with a screw driver.

Augmenting Interproximal Volume to Repair Prosthesis Loosening



Adding volume to the interproximal surface to repair loosening.



Create access hole on the occlusal surface with a bur.



Unscrew and remove the cemented prosthesis with abutment from the patient's mouth.



Add resin to the prepared space on the contact surface.



Screw back in the prosthesis and perform light curing. Aftermath, polish the contact surface.



Position the prosthesis in the mouth and tighten the screw with 25~30N-cm. Fill in the access hole.



Prosthetic Procedure 4

Impression Technique and Restoration Type

Overdenture Procedure

Positoner / Mini Ball / Magnetic Attachment

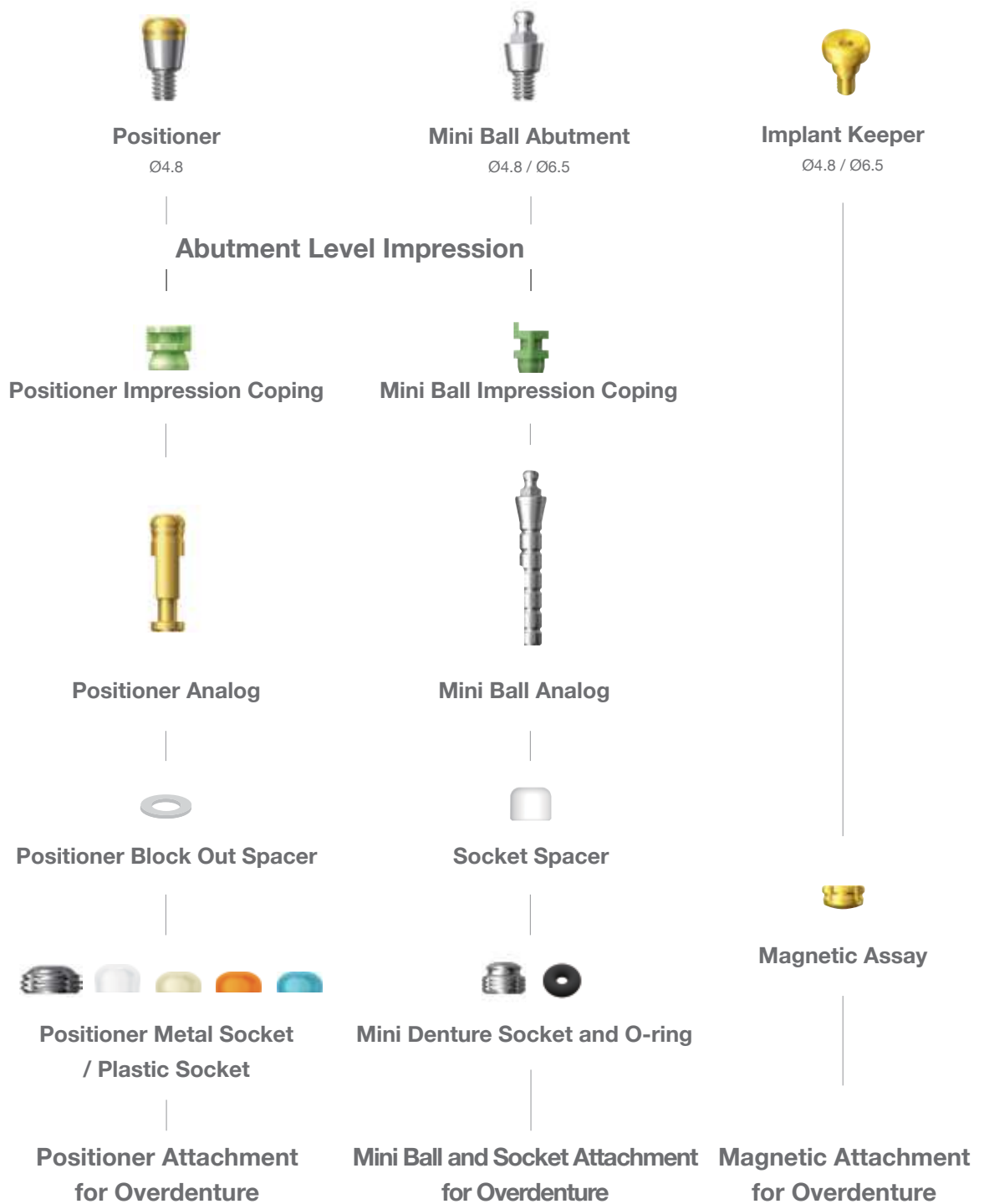

Positioner

Chairside



Connect the Positioner Abutment onto the fixture.

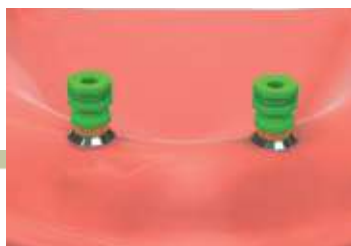

Affix the impression coping on the Positioner Abutment.

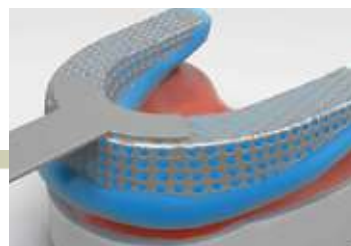

Take impression for the production of the individual tray.



Produce the individual tray for denture impression.



After connecting the Positioner Abutment and the impression coping together, apply the impression material.



Take the final impression with the prepared individual tray.

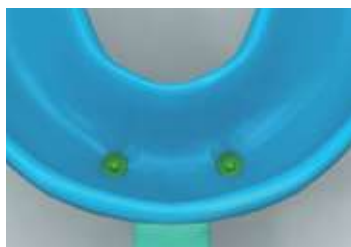

After the impression material is set, discard the individual tray.

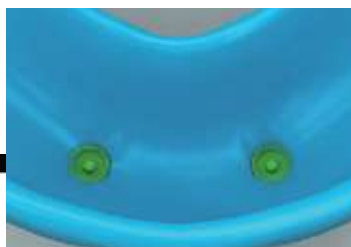
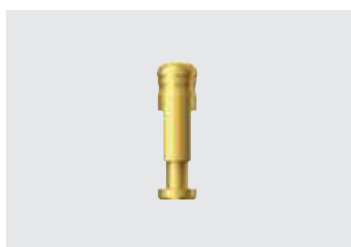
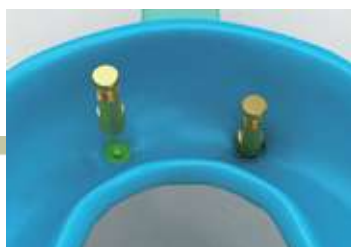

Image of the set final impression (with impression coping).

Lab side



Positioner Analog.



Insert the Positioner Analog into the embedded impression coping.



Create the master model.



"Block out" procedure to achieve the space required for the metal socket.



Fabrication of the denture with conventional method

Positioner

Case 1



Secure spaces for the female sockets.



Apply a small amount of resin into the space created for the metal socket.



Remove the denture after the resin is fully set. Image of the denture with the metal socket.

Chairside



Place the "block out spacer" on the Positioner Abutment in the patient's mouth.



Position the denture in the mouth and wait until the resin is completely set.



Remove the block out spacer from the patient's mouth.



Connect the metal socket onto the Positioner Abutment.



Remove the white plastic socket (100gf) using the positioner tool and replace with a regular plastic socket of a desired retention force (300, 500 or 1000gf).



Polish and the overdenture is complete.

Case 2



Create holes for the placement of the metal sockets.



Examine for interference between the inner surface of the holes and the female sockets.



Apply additional resin around the metal socket where there is a shortage of resin.

Chairside



Place the "block out spacer" on the Positioner Abutment in the intraoral.



Apply the resin into the holes and wait until it is completely set.



Apply resin around the metal socket.



Connect the metal socket onto the Positioner Abutment.



Remove the white plastic socket (100gf) using the positioner tool and replace with a regular plastic socket of a desired retention force (300, 500 or 1000gf).



Polish and the overdenture is complete.

Ball Attachment

Chairside



Connect the Ball Abutment with the fixture.



Affix the impression coping on the Ball Abutment.

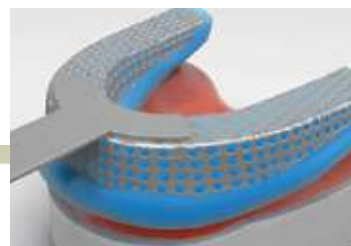

Take impression for the production of the individual tray.



Produce the individual tray for denture impression.



Apply the impression material.



Take the final impression with the prepared individual tray.



After the impression material is set, discard the individual tray.

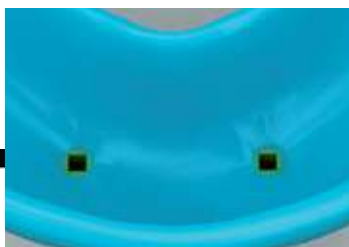

Image of the set final impression (with impression coping).

Lab side



Ball Analog.



Insert the analogs into the embedded impression coping.



Create the master model.



Socket spacer.



Fabrication of the denture with conventional method.

Ball Attachment

Case 1



Secure spaces for the female sockets.

Chairside



Connect the female sockets to the Ball Abutment in the intraoral.



Apply small amount of the resin into the secured area.



Position the denture in the mouth and wait until the resin is completely set.



Female sockets are placed in the denture.



Polish and the overdenture is complete.

Case 2



Create holes for the placement of the female sockets.

Chairside



Connect the female sockets to the Ball Abutment in the intraoral.



Examine for interference between the inner surface of the holes and the female sockets.



Apply the resin into the holes and wait until it is completely set.



Place the female sockets.



Apply resin around the female sockets.



Polish and the overdenture is complete.

Magnetic Attachment

Chairside



Remove the Healing Abutment.



Connect implant keeper with the fixture and tighten it with 25~30 N-cm.



Implant keepers connected with the fixtures.



Position the magnetic assay on the implant keeper.



Secure spaces for the magnetic assays.



Examine for interference between inner divets of the denture and the magnets.

Case 1



Apply resin on the divets of the denture's inner surface.



Position the denture into the mouth and wait until the resin is completely set.



Position the denture into the mouth and wait for initial setting.

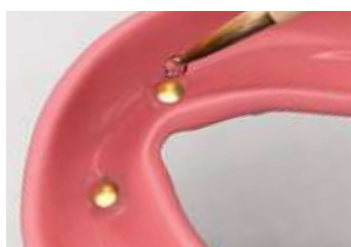

Remove the denture and apply resin around the magnets.



After the resin is completely set, remove excess. Polish and the overdenture is complete.

Magnetic Attachment

Case 2



Create holes for the placement of the magnets.



Examine for interference between the inner surface of the holes and the magnets.



Apply small amount of resin into the hole.



Position the denture in the mouth and wait until the resin is completely set.



After initial setting, remove denture from the mouth.



Add the resin around the magnets.



Polish and the overdenture is complete.

DENTIUM LONG-TERM CLINICAL DATA

2002

2003

2004

2005

2006

2007

2008

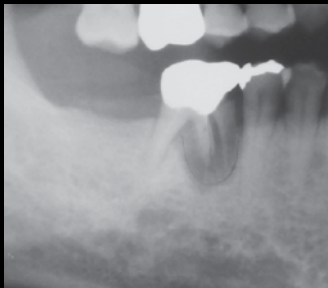

2002. 05. 17
Pre-op

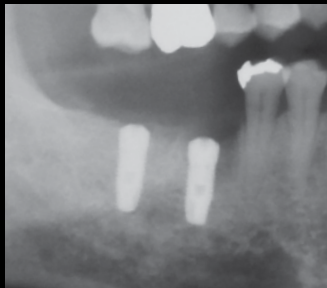

2002. 09. 04
Post-op



2003. 03. 15
Final prosthesis

Dentium

For Dentists By Dentists

2009

2010

2011

2012

2013

2014

2015

11 YEARS



2008. 04. 14
5 years

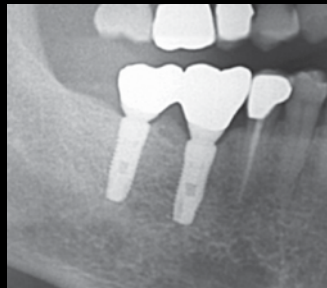

2013. 12. 05
11 years

over
10 years
of Long
term
data

OVER A **DECADE** OF
COMMITMENT TO
THE **BEST PRODUCTS**
FOR DENTISTS AND
PATIENTS

SimpleLine II

Product/Manual Catalog

Dentium
For Dentists By Dentists

Specifications are subject to change without notice.
Some products listed in this catalog are not available in the market due to pending approval.

HEAD OFFICE

501 Gyeonggi R&DB Center, 105 Gwanggyo-ro, Yeongtong-gu, Suwon-si, Gyeonggi-do, Korea [443-270]

T +82-31-888-5431 F +82-31-888-5430

E-mail biz_mail@dentium.com / www.dentium.com

SL2PM-1611[Rev.1]

